

KCMO-TV Broadcast News

Volume No. 160, December 1976



KCMO-TV Rolls into Commercial Production
with "Minimote" Mobile TV System

Meet the TK-46 from RCA.

Successor to the world's most successful TV studio cameras.

What's new on the TK-46?

Better signal-to-noise ratio, for one thing. In low light, a new, advanced preamp design improved signal-to-noise ratio by 3 dB—especially useful in multiple-generation tape production.

Also new for the TK-46 is a tiltable viewfinder with an 8" diagonal screen. The cameraman can hold a horizontal view while tilting the camera through a 30° arc.

Simultaneous in- and out-of-band contours with combing and coring are standard on the TK-46.

Feature	Year Introduced	69	70	71	72	73	74	75	76
High Efficiency Prism Optics		●	●	●	●	●	●	●	●
Wide Range Voltage Regulation		●	●	●	●	●	●	●	●
Comb Filter and Coring		●	●	●	●	●	●	●	●
Chromacomp		●	●	●	●	●	●	●	●
Electromechanical Lens Cap		●	●	●	●	●	●	●	●
Small Diameter Mini Cable			●	●	●	●	●	●	●
Joystick Remote Control Panel				●	●	●	●	●	●
Internal Bias Light	TK-44A				●	●	●	●	●
Extended Sensitivity					●	●	●	●	●
Scene Contrast Compression					●	●	●	●	●
Compact Camera Control Unit				TK-44B	●	●	●	●	●
Simplified Set-Up Controls					●	●	●	●	●
Automatic Color Balance					●	●	●	●	●
Automatic Iris Control					●	●	●	●	●
Automatic Centering Control					●	●	●	●	●
Indoor /Outdoor Switch					●	●	●	●	●
Super Quiet Switch					●	●	●	●	●
Out of Band Aperture Equalization						●	●	●	●
Shared CCU with Portable Camera Head							●	●	●
New State-of-the-Art Preamps						TK-45		●	●
Tilting Viewfinder								●	●
Simplified Control Panel Layout								●	●
Accident-Proof Set-Up Controls								●	●
Simultaneous In /Out of Band Aperture Equalization								●	●
Operations-Oriented Styling								●	●
									TK-46

Chronology of a winner.

The TK-46 is a new camera.

But far from unproved.

It is actually the distillation of years of brilliant camera performance. With features introduced to the industry on the TK-44 and its successors.

Features proved in more than 1,300 of these cameras. Features improved, where possible, for the TK-46. To make it the worthy successor to the world's most successful TV cameras.

Above are 25 reasons why the TK-46 makes superb pictures.

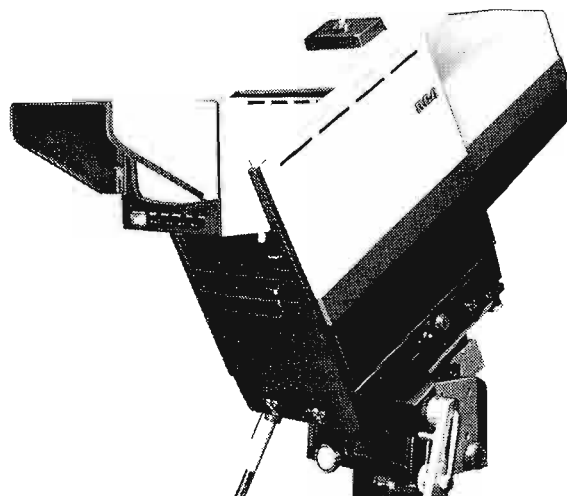

Our chart will show you all the advantages and how long they have been performance proved.

To see what all the TK-46 excitement is about, see your RCA Representative.

RCA



Page 4

Two Unique Mobile TV Systems for Production and ENG (Cover Story)

For on-location production, KCMO-TV, Kansas City, designed 'Minimote', a self-contained mobile TV system that is battery-operated and equipped with a TKP-45 camera and a TPR-10 portable quad VTR. For ENG, total system planning resulted in an operation that's fast, flexible and efficient.

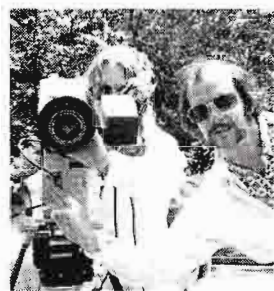

Page 12

WDCA-TV Upgrades and Innovates

This resourceful UHF station continuously upgrades facilities for added efficiency and revenue. Latest additions include a TV production van, computer editing system, and TCP-1624 Film Cartridge System.



Page 16

On-Location Can Be Anywhere for Channel 80, France

A new mini-mobile unit, equipped with two TKP-45 cameras and a TR-600 VTR, enables this independent French teleproduction company to handle a gamut of field assignments in or outside of Europe.

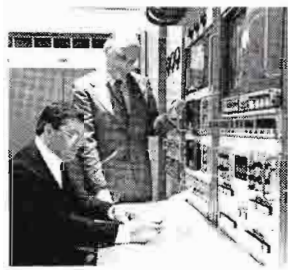

Page 20

WKYC-TV Plans a Future-Compatible Transmitting System

Careful system planning preceded installation of a new TT-50FL, 50 kW parallel transmitter at WKYC, Cleveland. Preparation, logistics, layout and operating details are included.



Page 28

Merrill Lynch Invests in TV

A broadcast quality color television facility helps this giant securities firm produce highly professional video programs for its numerous headquarters and branch operations.

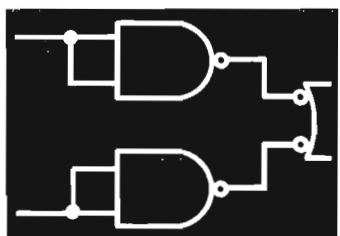

Page 32

Digital Fundamentals for the Broadcaster

With basic logic gates as the starting point, this article proceeds to familiarize the equipment user with the background, terminology and characteristics of digital circuits and systems.

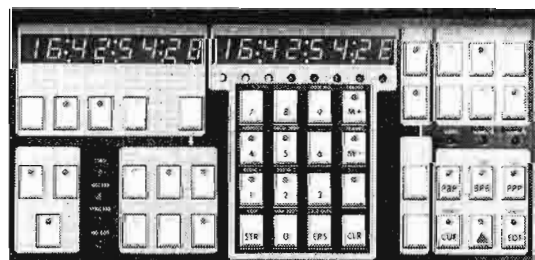

Page 42

New On-Line Quad VTR Editing System

The AE-600 Editing System provides users of the TR-600 with a built-in capability for faster and more creative tape editing. System design and operational features which give this new system the versatility to handle complex, creative edits are discussed.

View Finder

RCA Color TV Studio Systems Valued At \$800,000 For PTL Net Expansion

The PTL Television Network, a non-profit religious program production and distribution group, is expanding the capabilities of its Charlotte, N. C. center with RCA color television studio equipment valued at approximately \$800,000.

The equipment includes four RCA TK-46 studio cameras, two TR-70 and two TR-600 quadruplex video tape recorders, editing systems and associated equipment.

The TV systems will augment a wide array of RCA cameras, film equipment and tape recorders already installed in PTL Television's new multi-million dollar production facility.

Jim Moss, Executive Vice President, explained that the group's mission is to provide Christian programming to television audiences around the world. (PTL stands for Praise The Lord.)

Currently the network produces two hours of daily programming for live broadcast in Charlotte. Programs are recorded on video tape, dubbed and distributed to more than 70 stations and cable outlets, going to almost every state in the U. S., Mr. Moss said. "We'll gradually be expanding our au-

Host, Jim Bakker and Co-Host, Henry Harrison interview personalities, produce a variety show and maintain a 90-phone International Counseling Center in Charlotte, N. C. PTL studio is considered the largest single TV studio in the U. S.



diences into Europe and elsewhere around the world," he added.

The talk-show/variety programs, known as the PTL Club, consist of interviews with Christian celebrities, gospel musical groups, and other religious subjects.

New studio cameras on order will free existing units for installation in the group's mobile TV production van. The 30-foot mobile unit will be equipped with three TK-44 cameras, a TKP-45 studio-quality portable camera, and video tape, switching, monitoring and audio systems.

It will be used for on-location production of the talk show/variety programs as well as for special programming for the Great Church Series, highlighting Christian churches engaged in outstanding evangelistic outreaches, according to Mr. Moss.

RCA TCR-100 Video Tape Cartridge Systems For Australian Broadcasters

Six commercial television stations in Australia have ordered RCA TCR-100 video tape cartridge recorders to automate station breaks and to increase local production capabilities.

The orders were placed this summer with RCA Broadcast Systems, Camden,

N. J. The cartridge systems are used by broadcasters for sequential "on-air" playback of commercials, station identifications, program promotions and other short taped segments.

The systems also are used for the preparation of program material, such as commercials and promotions, and for other production requirements.

The TCR-100's on order will be the second systems to be installed by CTC, Channel 7, Canberra (the National Capital); TNT, Channel 9, Launceston (North Eastern Tasmania); CBN, Channel 8, Orange (Central Tablelands); GMV, Channel 6, Shepparton (Goulburn Valley); BTV, Channel 6, Ballarat (Victoria). MVQ, Channel 6, Mackay, Queensland, will be putting its first TCR-100 into operation.

RCA Transmitting Systems Ordered By South Carolina ETV-Net

The South Carolina Educational Television Commission has ordered RCA TV transmitting equipment, valued at approximately \$425,000, to establish the eighth station in its statewide network.

The equipment, which includes a 30-kilowatt UHF transmitter and high-gain antenna, will be used for a new education station in Rock Hill, S.C., to serve the northcentral part of the state.

Henry Cauthen, President of South Carolina ETC, said the network currently operates three FM stations and seven TV stations. Rock Hill, scheduled to begin broadcasts next year, will add a new source of local programs for its viewing area.

The network's color production facilities in Columbia and its fully-equipped color TV mobile broadcast units produce programming for the group's stations. Individual outlets also prepare local shows to augment network and PBS programming.

WFIE-TV Increases Coverage Area

WFIE-TV, Evansville, Ind., will approximately double its coverage area early next year when it completes installation of a new RCA transmitting system.

The Orion Broadcasting Inc. station will replace its current system with an RCA 55-kilowatt UHF transmitter and custom-built high-gain antenna, valued at approximately \$650,000.

The TTU-55 transmitter will combine with the pylon antenna to produce a selected directional signal for Channel 14 of more than 2.2 million watts effective radiated power. The antenna will be installed on a new 1,000 foot tower.

Marion B. Paul, Chief Engineer, said WFIE-TV presently broadcasts at 200 kilowatts maximum ERP in an omnidirectional pattern. "Our new higher power transmitter, directional antenna and tall tower will not only increase our coverage area, but will provide better picture quality for our present viewers," he said.

Ten RCA TK-76 Cameras Ordered By Hubbard

Hubbard Broadcasting Inc., of St. Paul, Minn., has ordered 10 RCA TK-76 portable color TV cameras to increase the electronic newsgathering activities of its owned and operated television stations.

Stanley E. Hubbard, Chairman and Chief Executive, said the new camera systems will expand on-the-spot news coverage by the group's three stations: KSTP-TV, St. Paul-Minneapolis, Minn.; KOB-TV, Albuquerque, N.M.; and WTOG-TV, St. Petersburg, Fla.

The new units manufactured by RCA Broadcast Systems, Camden, N.J., will join other TK-76 cameras already in use at Hubbard stations.

RCA TT-50 FH Transmitters For Cosmos Broadcasting

WSFA-TV, Montgomery, Alabama, owned and operated by Cosmos Broadcasting of Columbia, South Carolina, has ordered two 25,000-watt TT-50 FH highband 50kW VHF-TV transmitters and a TW-12A-12 traveling wave antenna as part of an overall expansion move.

The TT-50 FH is a fully redundant system comprised of two complete 25kW transmitters combined to deliver 50kW visual and 11kW aural output in the 174-216 MHz band. Excellent quality picture and sound, high reliability, and minimum operating costs are prime attributes. The TT-50 FH is a fully redundant system that greatly reduces the possibility of power outages.

The RCA TW-12A-12 VHF traveling wave antenna with its high power handling capability meets the requirements of broadcasters who prefer to use less gain in the antenna and higher transmitter power to achieve maximum ERP.

The expansion program is expected to be completed in 1977 under the super-

INSTANT IMAGERY—RCA's Bill Haneman and NASA's Chuck Vermillion (right) examine high resolution weather satellite picture received almost instantaneously by a new RCA-built earth station. The station was recently demonstrated publicly for the first time by NASA. These weather pictures have nine times better resolution than those produced by the Automatic Picture Transmission (APT) System developed in the early 1960s. The station was designed and built by RCA Astro-Electronics, Princeton, N. J., for NASA Goddard Space Flight Center.

The earth station consists of an eight-foot diameter automatic tracking antenna, receivers to accommodate the imagery, a special purpose signal processor for improved picture quality, a tape recorder and a high-resolution laser reproducer.



New RCA-Built Weather Station Demonstrated Publicly For First Time By NASA

A new RCA-built earth station, capable of receiving high-quality weather pictures directly from orbiting satellites, was demonstrated publicly for the first time today at NASA's Goddard Space Flight Center, Greenbelt, Maryland.

High resolution pictures of the Eastern Seaboard were transmitted by the Improved TIROS Operational System (ITOS) satellites as they passed within 1500 miles of the station. It takes approximately one minute for a picture to be processed after it is received.

Called a Local User Terminal (LUT), the station was designed and built by RCA Astro-Electronics, Princeton, N. J., for operational demonstration purposes.

The earth station consists of an eight-foot diameter automatic tracking antenna, receivers to accommodate the imagery, a special purpose signal processor for improved picture quality, a tape recorder and a high-resolution laser reproducer.

The terminal can be operated by one person and is capable of being trans-

ported and set up at any location on the globe to help provide improved weather forecasting.

The LUT produces photographic quality imagery that is nine times sharper in resolution than the Automatic Picture Transmission (APT) System developed in the early 1960's. For example, the APT has a resolution of 4.5 nautical miles in nighttime versus .5 nautical miles for the LUT. In daytime, the LUT imagery has a resolution of .5 nautical miles while the APT is 2 nautical miles.

"The terminal is capable of receiving Advanced Very High Resolution Radiometer (AVHRR) pictures from the next generation TIROS-N weather satellite, scheduled to be operational in 1978," according to Mark Sasso, Manager of RCA's Satellite Programs.

"Horizon-to-horizon pictures transmitted via the satellite are automatically corrected for earth curvature and rotation and include automatic annotation showing the date, time and pass of each satellite," Mr. Sasso said.

"Signals are processed digitally offering the capability for the LUT to be coupled with an auxiliary date processor to provide automated enhancement and analysis," he added.

vision of Mr. Richard C. Payne, Chief Engineer of WSFA-TV. Cosmos Broadcasting also owns and operates stations in Columbia, South Carolina; Toledo, Ohio; and New Orleans, Louisiana.

ATV-O To Install RCA TR-600 Video Tape Recorders

ATV Channel 0, Melbourne, Australia, has ordered two RCA TR-600 video tape recorders to handle an increasing program and commercial production workload.

The tape recorders, manufactured by RCA Broadcast Systems, Camden, N. J., will augment TR-70C recorders and TCR-100 video tape cartridge machines already in use at the station for airing of taped programs, commercials and promotional material.

The TR-600 combines compact size with built-in automated performance features, such as a chrominance amplitude corrector, velocity error corrector, color dropout compensator, electronic splicer, control track phasing, and guide and tape tension servo systems.



KCMO-TV

Designs Two Unique Mobile TV Systems
For Production and ENG . . .

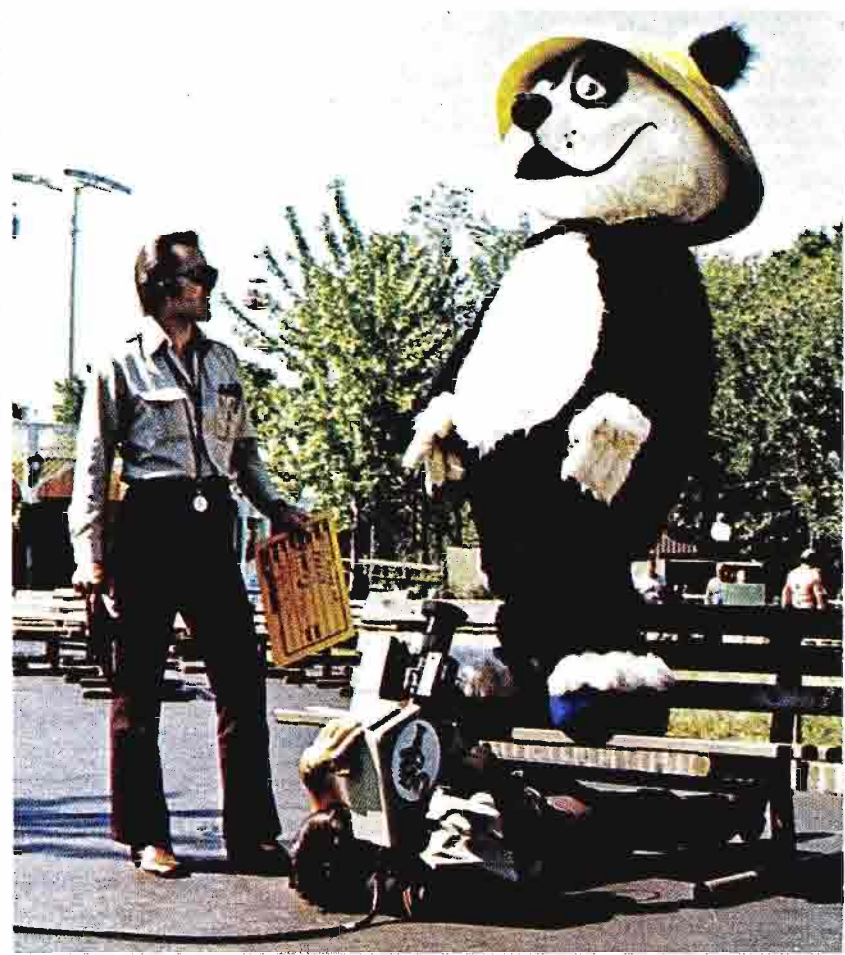

KANSAS CITY

When a TV production crew handling a remote is set up and ready to roll tape within 15 minutes of arriving at the location—that's news.

KCMO-TV, Kansas City, is performing this unusual feat just about every day, with its Minimote™ system, a unique portable, self-contained television production unit. The term "Minimote", which has been trademarked by Meredith Corporation, combines two words that are the key to its value and utilization: *miniature* and *remote*.

"Minimote" packs a lot of television production capability: an RCA TKP-45 color camera; control electronics; TPR-10 portable quad VTR; color playback equipment; audio, and other support gear. And all of this is neatly packaged to fit into an electric, battery-powered industrial type vehicle which stands only 65-inches high; 30-inches wide and 52-inches long, and weighs just 1200 pounds. The "Minimote" system is transported to and from location by a van which is equipped with a "cherry picker", allowing the crew to obtain a wide range of camera angles from heights up to 35 feet. The cherry picker also mounts a microwave antenna for direct transmissions back to the studio when "Minimote" is used on ENG assignments.

Studio Quality Production Capability

Steve Smith, Director of TV Engineering for Meredith Broadcasting, developed the concept of "Minimote". He saw the need for a remote unit capable of studio quality production—one that offered more mobility and at less cost than conventional remote broadcast units. With a market research study confirming the potential for "Minimote" in TV commercial production, Mr. Smith pushed the idea through the stages of visualization, feasibility, design and fabrication. Once it became operational, "Minimote" quickly proved its effectiveness.

In use now for 18 months, "Minimote" has fully measured up to expectations. It is solidly booked for commercial production, and, because of its versatility, is also used for occasional special ENG assignment so Jack McKain, Assistant Director of Engineering of KCMO-TV, cites the following example to illustrate the versatility of "Minimote":

During the Republican Convention in August, TV-5 arranged to interview Mrs. Reagan in her suite at the Alameda Plaza Hotel. Handling the assignment was a breeze for "Minimote". Carried to the hotel in its van, "Minimote" rolled placidly through the crowded lobby, onto a freight elevator, to be whisked up to the 19th floor. From there, the mobile unit cruised down the hall to the Reagan suite; the cameraman carried the TKP-45 camera in, and a reporter conducted the interview without fuss or delay. In this case, Mr. McKain notes, the interview was taped for later broadcast, but it could have been microwaved direct to the studio if desired.

Pre-Selling the Concept

A pre-selling promotional effort preceded the introduction of "Minimote" and helped assure its initial success, notes Production Manager Carl Chance. Although TV-5 was already into commercial production in their studio, agency producers and directors as well as clients still had to be convinced that video tape was competitive with film in quality and cost. Once this was accomplished, the other advantages of tape—speed, immediacy, efficiency—could be promoted. Since "Minimote" would be a single camera system shooting cinema style, it was felt that producers accustomed to film techniques would be more comfortable with it. This projection was confirmed when "Minimote" demonstrated its ability to deliver a quality tape product at an attractive price.

Fast, Smooth On-Location Set-Ups

The TV-5 production crew is delighted with "Minimote". The drudgery and busy work associated with TV on-location production—the hassles of equipment lugging, cable pulling and getting organized—have been eliminated. Set-up is fast and efficient, taking an average of only 15 minutes—an advantage appreciated by agency personnel and clients. Even more impressive, Steve Smith reports, is the quality of results achieved with "Minimote" on location.

The TKP-45 camera delivers studio quality color and has the automatic features for superior performance under less than ideal conditions. The portability and extreme light sensitivity of



"Minimote" rides to location shoots in a Kary Van which is equipped with cherry picker and microwave.



Ramp attached to rear bumper of van permits easy loading and off-loading of "Minimote" cart.



TKP-45 portable color camera used with "Minimote". Its automatic features and light sensitivity make it ideal for indoor and outdoor shoots.

Post-production tape facilities at TV-5 have been expanded to meet production demands. When complete, the installation will include three TR-600 tape machines, each with AE-600 Editing Systems.

the camera have been valuable assets for remote shoots, Mr. Smith adds. The camera's ability to operate indoors and outdoors and to accommodate widely varying light levels automatically is particularly useful for location work.

TPR-10—Portable Quad with Color Playback

Contributing to the overall excellent on-location performance of "Minimote" is the TPR-10 quad tape machine which records NTSC highband color signals with quality equal to studio VTR's. The small size and packaging of the TPR-10 made it easy to fit into the "Minimote" concept of portable, self-contained systems. Another major feature of the TPR-10 for remote production, according to Mr. Smith, is its color playback capability. This permits directors, producers and clients to determine immediately whether a scene is a "take" or must be re-shot.

On remote assignments, "Minimote" usually operates with a crew of four: a Director; two engineers, and a stagehand. The engineers handle technical details, including operating the camera and tape machine.

The mobility of "Minimote" and its fast set-up have been especially advantageous for handling commercials requiring a number of set-ups in a large area—such as shopping centers, retail stores, amusement parks. An early assignment for "Minimote" dramatically demonstrated its speed and mobility. For one 30-second commercial at "Worlds of Fun" amusement park in Kansas City, a TV-5 production crew shot 25 scenes at 17 different locations, all in 11 hours.

More Production in Less Time

The average time to change to a new shoot in the same general location, Mr. Smith states, is five minutes—including strike, move and set-up.

At shopping centers, "Minimote" rolls from one location to another with amazing ease. Since there is no need for long camera cable runs or for checking availability of AC power, de-



lays in setting up are minimal, and more production can be accomplished in less time.

Over 30 locations in a shopping center were covered in one 8-hour shoot. At a department store, "Minimote" shot 16 locations in four hours. On another assignment, five 30-second spots were shot in three hours at three locations—and these were edited, dubbed and on-air on three stations within 36 hours.

The picture quality achieved with the "Minimote" system has been such that some clients have specified its use in situations where studio equipment could be employed. One Kansas City agency with its own in-house film/photographic studio brings "Minimote" in on a regular basis for handling tape commercials.

Another local client, a jewelry store, had used the TV-5 studio for producing commercials. This was a tense and involved operation, since the valuable jewelry had to be brought to the studio for televising. The costly items had to be carefully inventoried and security provided to minimize risk. Now, with "Minimote", the production crew sets up at the store in less than fifteen min-

utes and produces the commercials on location. The production operation is faster and more effective, with high quality results and far less risk to the merchandise.

New Post-Production Tape Facilities

Carl Chance, Production Manager, gauges the effectiveness of "Minimote" by the added production business resulting from its availability. Mr. Chance affirms that production activity at the station has expanded substantially in the past two years, with much of the growth directly attributable to "Minimote". As a result of the added post-production workload, generated by "Minimote", video tape and editing facilities had to be enlarged.

In the production/post-production area, KCMO is operating two TR-600 VTR's and a TR-22. The TR-600's had been used at the Olympic Games in Montreal, and were installed on an interim basis. By presstime for this issue of BROADCAST NEWS, the production facility will include three TR-600 tape machines, each equipped with AE-600 Editing Systems. The TR-600's were selected because they offered the best

performance-to-cost value, plus the state-of-art editing capability of the AE-600 Editing System. The tape machines are used for post-production assignments during the day, and for making dubs in the evening. In one marathon dubbing session, 2400 Western Auto commercials were dubbed in a two-day period.

Steve Smith recalls that the idea for a self-contained miniaturized TV production system came to him on the return trip from the 1974 NAB Convention in Houston. While a number of ENG cameras and cassette type video tape machines were demonstrated, he was more interested in smaller broadcast studio quality equipment for production use. The TKP-45 portable camera and TPR-10 portable quad VTR introduced by RCA at this show were designed for just this application.

"Minimote" Shapes Up and Rolls Out

By the fall of 1974, the concept had been developed, researched and reviewed with management to confirm feasibility, investment cost and potential profitability. Even the name "Minimote" had been selected. With management approval, initial orders for equipment were placed, particularly for the long-lead items.

Fabrication of "Minimote" began on May 1, 1975, without the benefit of exact plans or drawings. The overall size and performance parameters had

been established, but the packaging of the components required ingenuity, innovativeness, and an occasional dose of serendipity. The assembly plan for "Minimote" was referred to as "Design as you Build" by the TV-5 technical crew. Although specific plan drawings were not available, fabrication of the system proceeded on a disciplined, orderly basis. Remarkably, the entire project from start of fabrication to finished product was accomplished in less than 90 days. By mid-July of 1975, "Minimote" was operational and generating production revenue.

In its finished form, "Minimote" seems like a beautifully simple concept. And it is. But the path from idea to product was strewn with problems. Standard products were re-packaged to fit the compact space available. Electronics had to be re-arranged. Since battery operation was a key feature, it was necessary to find an efficient DC/AC inverter. Standard sine wave inverters were relatively inefficient, and would limit operation time with batteries to one hour. As a solution, high efficiency (94%) square wave inverters manufactured by Wilmore Electronics were selected. With the electronic equipment designed for sine wave operation, numerous problems were encountered in switching to the square wave inverter—such as video glitches and audio buzz—but all were resolved along the way.

Battery-Operated Electric Cart

An extensively modified Taylor Dunn electric industrial cart is the vehicle which houses all system components and gives "Minimote" its mobility and battery power. The cart itself is 52" long by 30" wide, and with the equipment rack in place, stands just 65" high—a predetermined size that permits the vehicle to fit easily into passenger elevators.

Four 6V batteries mounted in the base of the cart provide power for operating the vehicle and electronics for up to three hours, and also serve to stabilize the unit. An accessory battery cart is towed behind "Minimote" to provide for an additional three hours of battery operation without AC power or recharging. The cart can traverse grades up to 30%, including rough terrain, and has a top speed of 8 miles per hour.

The vehicle is operated from the rear, with the driver standing up. For better viewing in congested locations, a monochrome camera with a fisheye lens is fitted into the front of the vehicle, with the monitor at eye level directly in front of the driver. A rotating beacon and English Police horn give visual and audible warning signals to clear a path for the cart. It is also equipped with two-way radio for direct contact with the station while on location, and has intercom facilities for local communication.

At the front of the cart is a DC winch and cable which is used for assisting it on and off the van that carries it to the location.

All Electronics in One Compact Cabinet

"Minimote" electronics are rack-mounted in a custom-built cabinet which is only 30" wide, 32" long and 42" high. In this compact space are mounted:

- TPR-10 electronics and transport units (in sliding drawers)
- Two audio AGC amplifiers (one on each channel of the TPR-10 for double sound recording)
- 15" studio quality color monitor
- Tektronix 1480C Waveform Monitor
- Beston 561 Vector Display Adapter



TPR-10 portable quad VTR used with "Minimote" permits immediate playback in color to determine if a new "take" is needed.



New ENG vehicles in front of KCMO building. Van at left is a Type I or "mother" vehicle, with microwave capability. At right is the Type II reporter vehicle. This ENG system, designed by KCMO engineering, is being adapted for use by all Meredith Broadcasting stations.

- Camera Control unit for TKP-45 (modified, with NTSC Sync Generator built-in)
- DC-AC Inverters (Convert 24 VDC from cart batteries to 110 VAC, 60 Hz for all equipment)
- Two-channel audio mixer

In addition, the cart package includes wireless microphones; two-way radio; intercom; cables; portable lighting, and O'Connor Hydroped pedestal with dolly. There is even a special mount at the rear of the equipment cabinet for storing the TKP-45 camera head during transit.

A set of service wheels permits removing the entire rack from the cart to facilitate maintenance on the electronics and to access the batteries.



The TK-76 travels in style, in its own protected case. The camera's sensitivity and ability to operate at low light levels enhances its usefulness for ENG.



Type II vehicle ENG complement includes TK-76 camera; videocassette VTR; Time Code Generator, wireless mike. It is set up as a two-person operation, with a reporter and cameraman team assigned to each unit.

Kary Van with Cherry Picker

"Minimote" rides in style to remote shoots, securely buckled inside a Dodge Kary Van. A 10-foot ramp that is permanently attached to the rear bumper is raised and lowered by an electric winch to load and unload "Minimote". The vehicle is equipped with a Van Ladder cherry picker which is rotatable and extendable—up to 35 feet from the ground and 13 feet horizontally from the truck. An automatic leveling bucket perch on the end of the cherry picker gives the cameraman an unobstructed view for high angle shots. The top of the van also has a camera platform with folding safety rails.

Microwave System

For direct transmissions to the studio from remote locations, the van is equipped with microwave facilities with

a range of 25-35 miles. A four-foot circularly polarized microwave transmitting antenna is mounted on the cherry picker bucket. The 360-degree rotation provided by the cherry picker, and a 0-95 degree tilt mechanism provide vertical tilt so that the dish can be rapidly aimed at the receiving antenna on the KCMO tower. This 2 GHz circularly polarized receiving antenna system is installed at the 748 foot level of the tower.

In addition, a 2GHz microwave transmitter and two-foot circularly polarized transmitter antenna are contained in a portable "pod" which can be carried on the "Minimote" cart.

One of the advantages of the "Design As You Build" system approach is that it stimulates thinking on operational

improvements. The speed control for operating the "Minimote" cart was replaced by a solid state system which is 95% efficient and uses far less power than resistance coils. In the near future, a 3/4-inch videocassette recorder and SMPTE Time Code Generator will be added to the "Minimote" system. This will provide agency clients with an immediate copy of the tape shoot for screening and off-line editing, with resultant savings from the reduced editing time on the quad VTR's at the studio.

New ENG System for All Meredith Stations

Although designed primarily for the production of commercials, "Minimote" has also been effectively utilized for ENG applications. As such it served full-time as TV-5's first electronic news gathering unit while the new KCMO-

designed ENG system was being assembled. This new system is now in operation at KCMO and is being packaged and standardized for all of the Meredith stations. Meredith Broadcasting has purchased thirteen TK-76 cameras for ENG, four of which are for use at TV-5 for ENG and documentary production.

Steve Smith's concept of ENG operation is that all television equipment carried in a vehicle can be removed and remoted, thus providing added mobility as well as flexibility.

Four-Vehicle ENG Operation

The ENG function at TV-5 is set up as a four-vehicle operation. Three heavy-duty Chevrolet "Blazers" (designated as Type II units) each carry a TK-76 camera and accessories; videocassette recorder; time code generator, and wireless microphone. On normal assignments, each vehicle operates with a two-man crew—a cameraman and a reporter.

The fourth vehicle is a Ford Econoline van which is designated by TV-5 as a Type I or "Mother" truck. This unit is equipped with a roof-mounted rotatable cherry picker; a microwave system, and contains support equipment for the reporter vehicles. "Mother" carries a portable rack of microwave equipment mounted on a two-wheel cart, including a Nurad "Goldenrod" antenna. A four-foot microwave dish is mounted atop the cherry picker for better directivity and longer range. A second cart carried by "Mother" includes a rack-mounted videocassette recorder; video switcher; an off-air tuner and color monitor (converted to DC operation). This is used for relay-

ing (via microwave) tapes recorded by the Type II units.

Both the Type II and "Mother" vehicles would be used for handling scheduled as well as fast-breaking news. The reporter vehicle first on the scene records the action, using the TK-76 camera and videocassette recorder. If the event warrants, "Mother" would be dispatched to the location and would provide direct microwave transmission back to the studio of the TK-76 camera picture, either for immediate airing or for recording for later playback. After the line feed, the initial cameraman/reporter coverage which had been recorded would be transmitted back to the station by "Mother" for recording and editing.

TK-76 Cameras . . . "Superb"

The reaction of the News Department to the change from film to electronic news gathering has been positive and professional at KCMO. For those long accustomed to the film medium, the idea of going on-air "live" produced some butterflies and jitters at first, but this soon changed. And, with material taped for later playback, there is essentially no difference in using film or video.

The TK-76 cameras have done a superb job, Mr. Smith comments, and the operators adapted to them quite readily. "The best features of the cameras are high sensitivity; ability to operate at low light levels, and automatic white balance. The overall performance of our TK-76's has been outstanding."

Studio ENG Facility is an Integrated System

Typically, TV-5 used the systems approach in planning their ENG facility.

The system is sophisticated, yet designed to simplify ENG operations. The Type II vehicles and the "Mother" van exemplify this integrated design. The technical set-up in the studio carries it even further. Located in Master Control, the ENG tape operation utilizes a micro-processor-controlled automatic switching system for flexibility and economy. It permits sharing Time Base Correctors so that a separate TBC is not needed for each recorder in the system: any assigned videocassette recorder is automatically connected to an available, unused TBC. The use of a time code generator with the field VTR's speeds editing time, since tape delivered to the station is SMPTE coded for editing.

The move to ENG has added to the workload of engineering, Mr. Smith acknowledges. One engineer has been assigned full-time to handle maintenance on the mobile units and microwave system. A second engineer operates ENG "Tech Center" equipment; records network and microwave feeds from the field units, and handles playback of edited tapes for on-air use.

Film Operation Not Totally Eliminated

According to Mr. Smith, the use of TK-76's for news will not totally eliminate film production, but it will mean that the station is discontinuing the in-house processing of film. TV-5 finished the conversion to ENG in late November and the film processor was shut down early in December. Further, Mr. Smith adds, all news programming at the station will be recorded and played back on the 3/4-inch tape format—even network news which until now has been recorded on quad tape machines for editing and playback.

Steve Smith, Director of TV Engineering

While still in high school, Steve Smith started his career in broadcasting, working at a local radio station. After earning a BSEE degree from the University of Missouri in 1964, he joined KCMO as Assistant Chief Engineer. In 1967 he left for a three-year tour with the U. S. Coast Guard, where he was involved in the development and procurement of equipment for Coast Guard radio stations, Loran stations and transportable communications. During this time, he completed requirements for a Master's Degree in Engineering Administration from George Washington University, with a thesis on the implications of automation in broadcasting. In 1970 he returned to KCMO as Chief Engineer for AM-FM-TV. Since April 1976 he has been Director of TV Engineering for Meredith Broadcasting and is now heavily involved in implementing plans for a new broadcast center for KCMO which is now under construction.

From Unique Mobile Units to a New Broadcast Center

The unique mobile television units deployed by KCMO-TV for commercial production and for ENG *were* exciting, innovative design projects.

“Minimote” is roving the Kansas City area—covering shopping centers; retail stores; amusement parks; convention centers and sports stadiums—producing sharp, colorful tape commercials for TV-5 clients.

“Mother” and the covey of ENG vehicles are in daily operation, and have also moved into other Meredith stations.

But these projects are history. Steve Smith and his technical staff are now involved up to their eyebrows in the fresh challenge of designing and equipping a new broadcast center for KCMO, scheduled to be operational in the summer of 1977. You have to move fast to keep up to date in Kansas City. □

Framed in steelwork, Steve Smith checks plans for the new KCMO-TV broadcast center scheduled to be operational next summer.

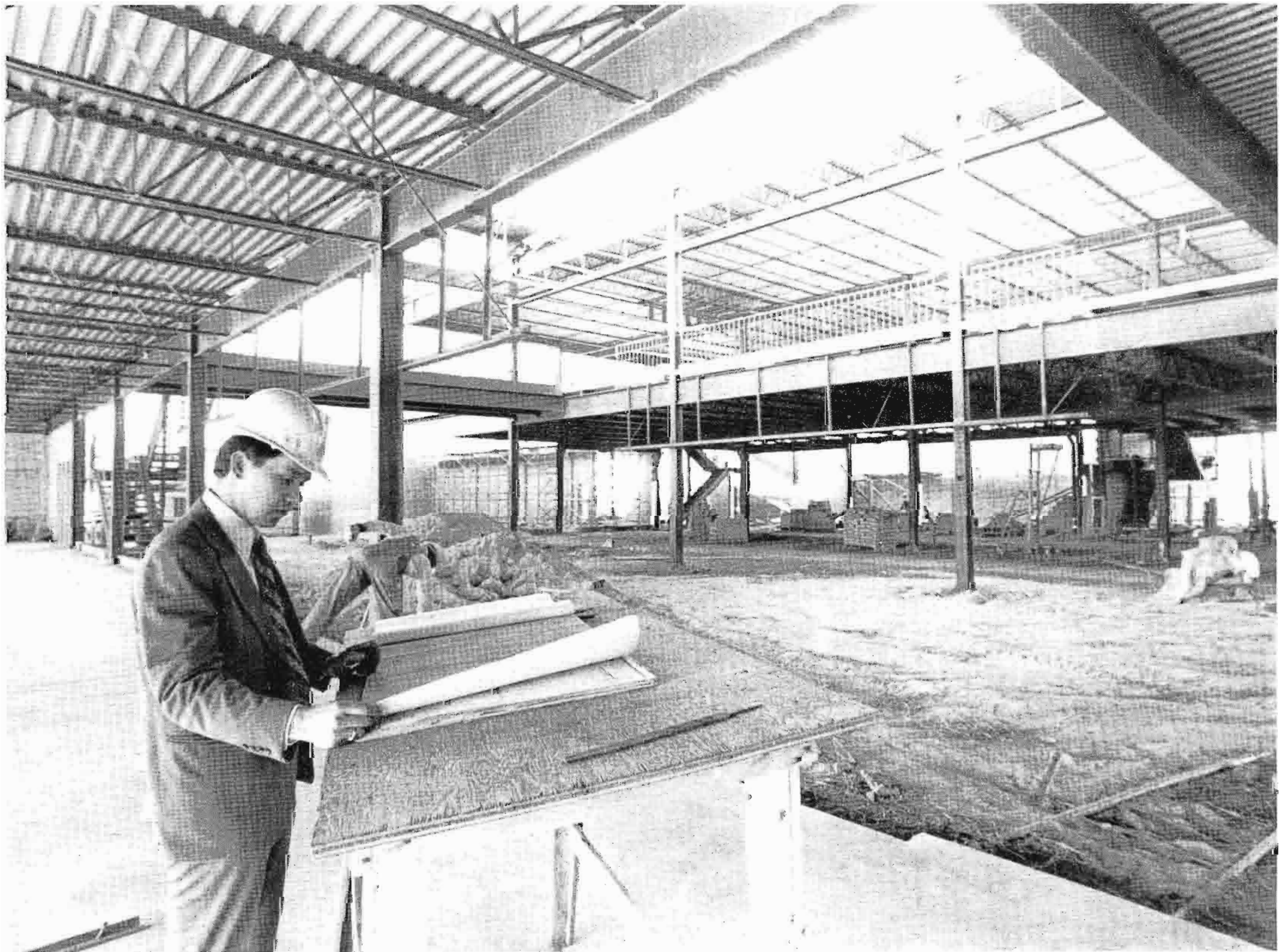

Capitol Building provides a convenient, functional backdrop for WDCA-TV's TKP-45 camera in making on-location political commercials.

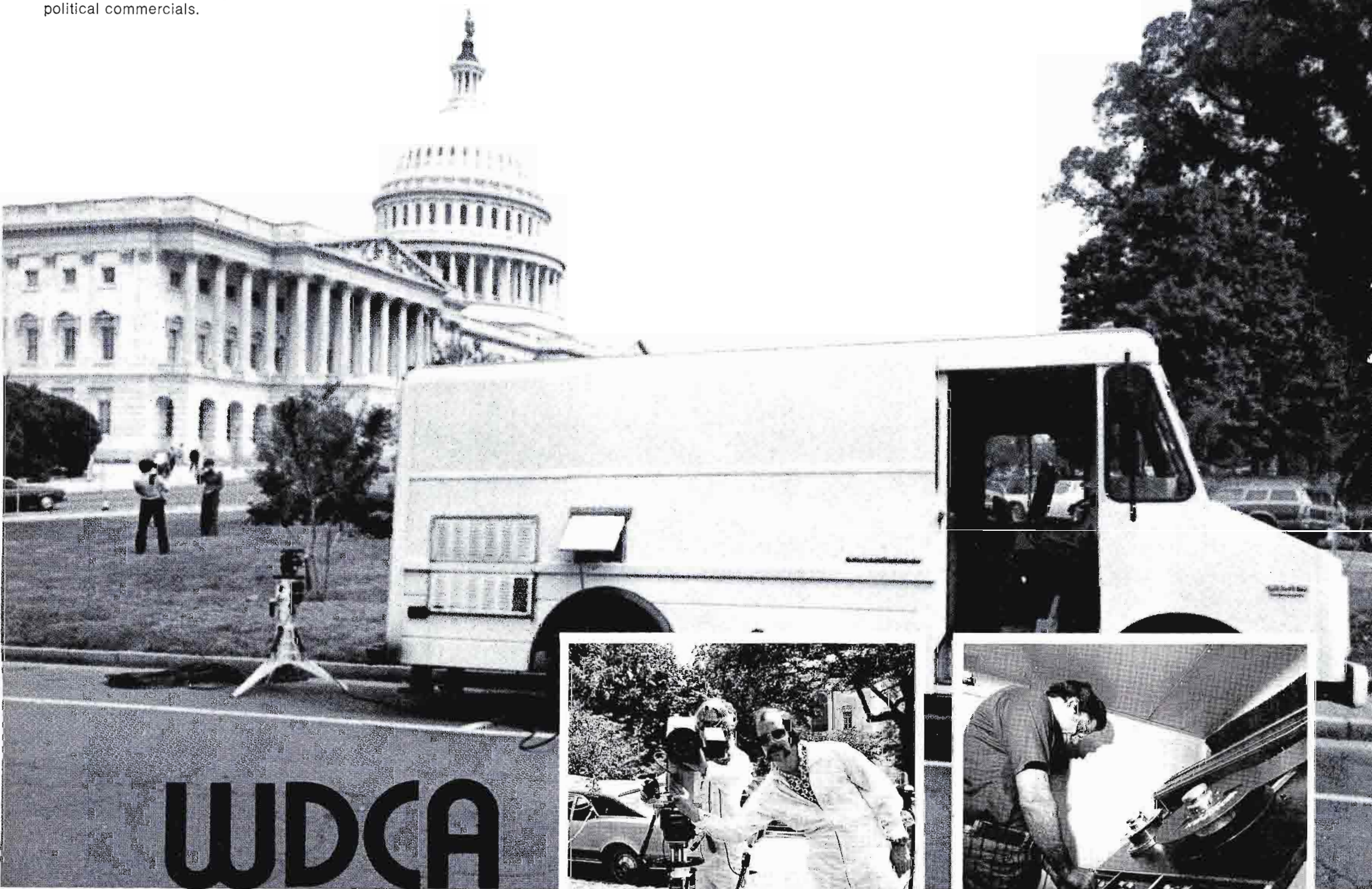

Improves Production and Operating Efficiency



TKP-45 Camera sets up quickly and produces studio quality color.



TR-600 mounted inside TV-20 van provides top quality recordings. One engineer handles the taping operation and shades camera on remotes.

WDCA-TV, Washington, D. C. has taken the innovative route to success. Since going on-air in 1966, Ch. 20 has been continuously upgrading its facilities—a condition which of itself is not unusual. For WDCA-TV, however, the improvements enable the station to keep technologically ahead and also serve as marketable assets.

For example, Milton Grant, Vice President and General Manager of WDCA, was one of the first advocates of the TCR-100 video cartridge tape machine. In 1969, as a result of his active interest, TV-20 served as the test location for the TCR-100, then a daring new automatic method of airing tape commercials and short program segments. This initial "cart" installation highlighted WDCA's pioneering spirit, and also resulted in enhanced operating efficiency and accompanying savings (see BROADCAST NEWS, Vol. 145).

Camera, Tape, Film System Additions

Several recent equipment investments by WDCA-TV reinforce this progressive image, and also contribute substantially to the profitability of the station's operations:

- A TKP-45 Portable Color Camera and TR-600 Tape Recorder operating from a compact van have improved production capability for handling high quality on-location assignments.
- A computer editing system and 2-inch helical scan VTR's have added new versatility to post-production operations.
- A TCP-1624 Film Cartridge System has reduced strain on the telecine operation, while freeing 16mm projectors for production.



Production Manager Bill Castleman with new computer editing system and video switcher in TV-20's production control facility.

Production Profit Center

At WDCA, the Production Department operates as a separate profit center. Production Manager Bill Castleman, young, intense and enthusiastic, reports that 90 percent of current production work involves television commercials, with promos and station-originated programs making up the balance. "We have the best equipment, a competent staff, and can do the job," he affirms.

The station has aggressively pursued commercial production business in the Washington market, and has been successful in attracting advertising agency accounts. TV-20's commercial production volume has increased by 400 percent in the past three years, and is continuing to grow, according to Castleman. He credits the new computer editing system, TKP-45 camera and TR-600 tape machine as key factors in expanding agency commercial production work. "With this combination, exact prices can be quoted to clients, without compromising quality standards or cutting corners."

For their tape commercials, the TV-20 production crew shoots cinema style, with a single camera taking both scripted and "wild" footage which is recorded on the TR-600. With tape, location production schedules go faster, Castleman says, because the producers and clients can screen and OK each sequence immediately to determine whether a re-take is needed. Most of the WDCA commercial productions are remotes, generally with a tightly

scripted story board, but sometimes free-wheeling and spontaneous.

Top Technical Quality

"We offer our customers a product of top technical quality, along with maximum creative potential and flexibility," Bill Castleman emphasizes. "The TKP-45 produces pictures equal in quality to those of much larger studio-type cameras, yet can be operated from the shoulder or mounted on a portable tripod. The camera's ability to function equally well indoors or out, and to make the switch instantly, is particularly useful for shooting on-location. The automatic features are excellent."

Don Doughty, WDCA-TV's Chief Engineer likes the quick set-up, the stability, and the fact that the TKP-45 camera control unit is standard and similar to that of the TK-44 studio cameras operated by the station. He also notes that the compatibility of the TKP-45 and TR-600 in producing highest quality tapes has made this equipment combination a good investment for the station.

A screening of the "house" reel of commercials produced by TV-20 confirms the competence and quality performance stressed by Mr. Castleman. National, regional and local spots are included. A "Pants Corral" commercial featuring Levis was one of the first done with the TKP-45, winning three awards, both local and national. Other spots for Peoples Drugs are a combination of in-store and studio productions, including an opening with a 9-way split

screen. Some effective commercials were built from slides and still photos, creatively assembled from precise computer edits.

Van Packed With Production Capability

Aesthetically, the WDCA-TV production unit is not impressive, and is not meant to be. But it packs full on-location capability in a tight operating area. The TR-600 is bolted to the floor directly behind the driver's seat. About three feet to the rear of the TR-600 is a console which fills the entire width of the van, and includes a small audio board; vectorscope, monitoring, and the camera control unit for the TKP-45. One engineer handles taping operations and camera controls on remotes. For continuity, the assigned engineer stays on the production job from start to finish. The van carries 600 feet of cable for the TKP-45, reel-loaded at the rear, although most location assignments require less than 300 feet. The TR-600 has been an excellent production machine for TV-20, Mr. Castleman confirms. "For today's commercial production, a top-quality video tape recorder is essential to produce the accurate color and crisp visual impact the client is looking for. The TR-600 provides top-of-the-line studio quality in a compact size that suits it for small mobile unit installations like ours. Ease of tape loading and machine set-up make operation of the recorder a lot easier for a one-man production van."

Post-Production Operations

Post-production operations at the WDCA studio mirror the emphasis on production. In addition to the computer editing system, a custom production switcher provides complete flexibility for inserts, chromakeys, splits, and a multitude of effects.

At TV-20, the Director (there are four on the staff) handles mix, effects and switching for his productions. Two helical scan 2-inch VTR's and a TR-70 are dedicated to Production. However, when needed, the TR-70 is available for on-air programming.

The quad "working master" which is recorded on the TR-600 is transferred at the studio to a 2-inch helical scan format, with time code added for computer editing. After editing, a helical scan master tape is produced, from which all dubs are made, including a protection quad master tape.

Master Control—Center of Action

While many stations isolate Master Control from machine operations, at WDCA it is a bustling action center, sharing space with monitoring and control facilities as well as the program and production video tape equipment. The tape complement includes two

TR-70's; a TCR-100 Cartridge Tape System; two 2-inch helical scan VTR's, and two video-cassette recorders.

Two engineers in Master Control handle normal station on-air and production operations. The Master Control operator does the on-air switching and loads the "cart" machine and the program TR-70 (the second TR-70 is shared with Production). The switcher operator also handles video control for the three TK-27 telecine cameras. A second engineer in Master Control is assigned to Production, shading the studio TK-44 cameras and operating the production VTR's.

The Master Control switcher is a 12-event, pre-set system, with built-in pre-rolls for tape and film machines. The operator must initiate all on-air switching manually with the "Take" bar.

Film "Cart" Machine for Telecine

TV-20 operates three TK-27 film islands and keeps them busy. A dramatic change in the telecine operation occurred when a TCP-1624 Film Cartridge System replaced a TP-66 projector on one of the islands. The TCP-1624 saves four projectors and airs the film spots smoothly and automatically, Don Doughty says. Before the film "cart"

system was installed, all film spots were loaded and played individually on the TP-66 projectors. A spot reel was not made up, according to Mr. Doughty, because of its inflexibility in handling repeat commercials. Consequently, as many as six projectors were used for running the film spots and programs. Even with three telecine systems, scheduling was tight, and the projectionist's lot was miserable at best.

Now, one of the TK-27 islands is available full time to the Production Department. A second island is used for airing film programs, and the TCP-1624 effortlessly handles the film spot commercials and PSA's — averaging about 150 plays each day, with the volume increasing during the busier fall and winter seasons. TV-20 has 1,000 film "carts" on hand, with more than 800 loaded, and 10-15 new commercials added to the "cart" film file daily.

With the TCP-1624, handling film spots is routine. The Telecine operator loads the magazine tray in the sequence called for in the log, and the Master Control operator pre-sets the film "carts" for on-air play, using a thumbwheel sequencer built by the station's engineering staff.



Master Control operator at TV-20 handles on-air switching, loads TCR-100 "cart" machine and TR-70 VTR and shades film cameras when necessary.

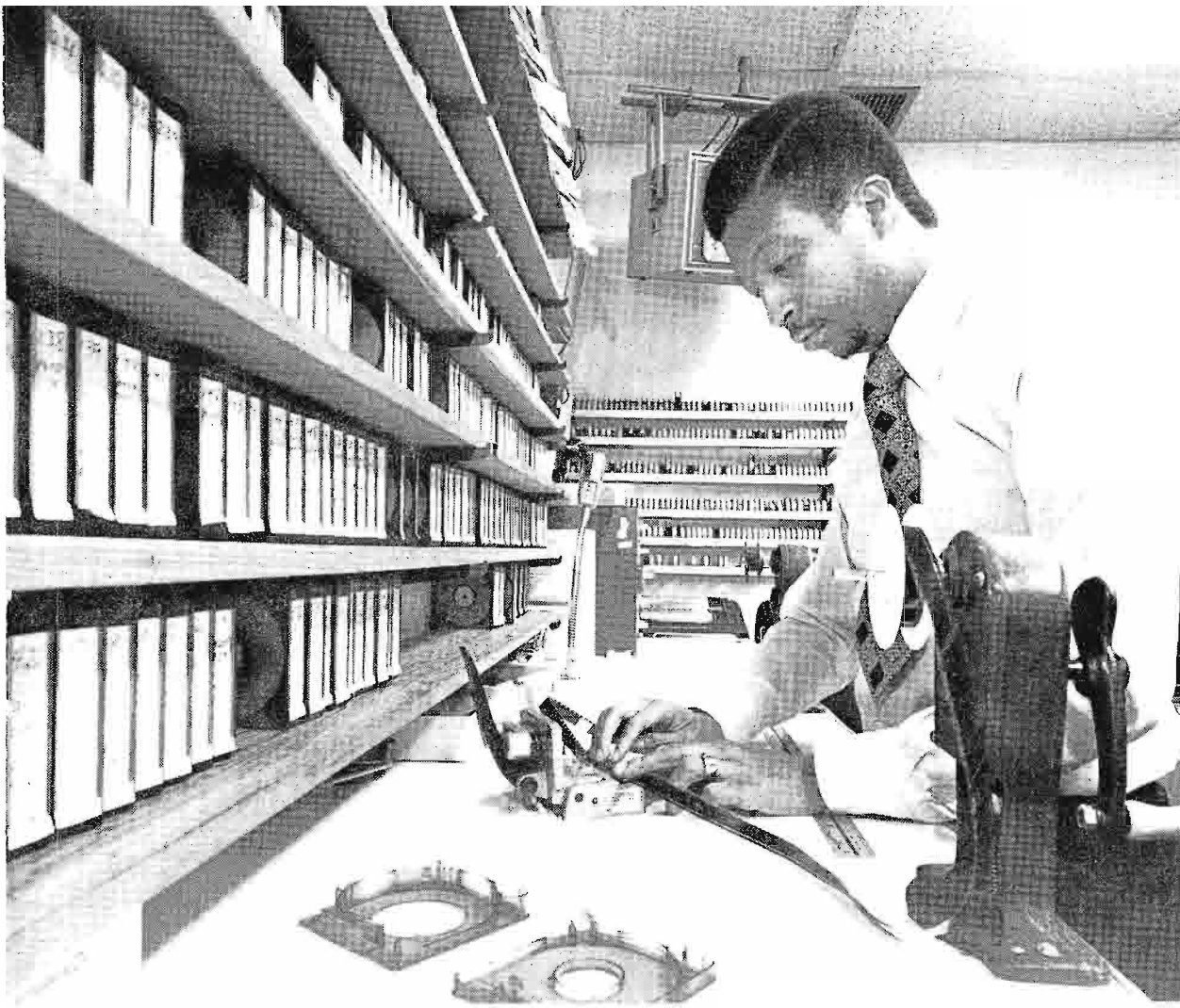

One of the pleasant surprises in adding the TCP-1624, Mr. Doughty says, is the ease of installation. The two-projector system is self-contained and shipped mounted on a dolly, ready to roll into position for optical alignment. It was actually easier to install than the TP-66 it replaced, adds Mr. Doughty. Maintenance for the film "cart" system is performed routinely on a weekly basis.

TCR-100 Keeps Rolling Along

The prototype TCR-100 tape "cart" machine which was installed in 1969 was replaced in 1972 with a new model—which now has logged more than 180,000 plays on each deck. An average of 300 tape "carts" are aired daily. The TCR-100 has been an outstanding performer, Don Doughty readily acknowledges. Aside from its convenience and time-saving advantages, the "cart" delivers consistently good color quality on air, he says. At WDCA, all tape spots as well as station promos and ID's are dubbed to "carts".

The TCP-1624 and TCR-100 are particularly valuable to WDCA because as a commercial UHF with independent programming, the station runs far more spots than network affiliated stations.

Keeping Ahead

The new camera, tape and film facilities at WDCA have resulted in improved operating efficiency and production capability. They are continuing the station's tradition of moving ahead with technology. And, of even greater significance to management, the innovations are paying off as profitable investments. □



TCP-1624 Film Cartridge Projector system has eased strain on Telecine. Incoming film spots are easy to load in cartridge. Up to 24 "carts" can be loaded on magazine.

WDCA-TV pioneered use of TCR-100 "cart" machine, with first system installed in 1969. On average, 300 tape "carts" are aired daily.

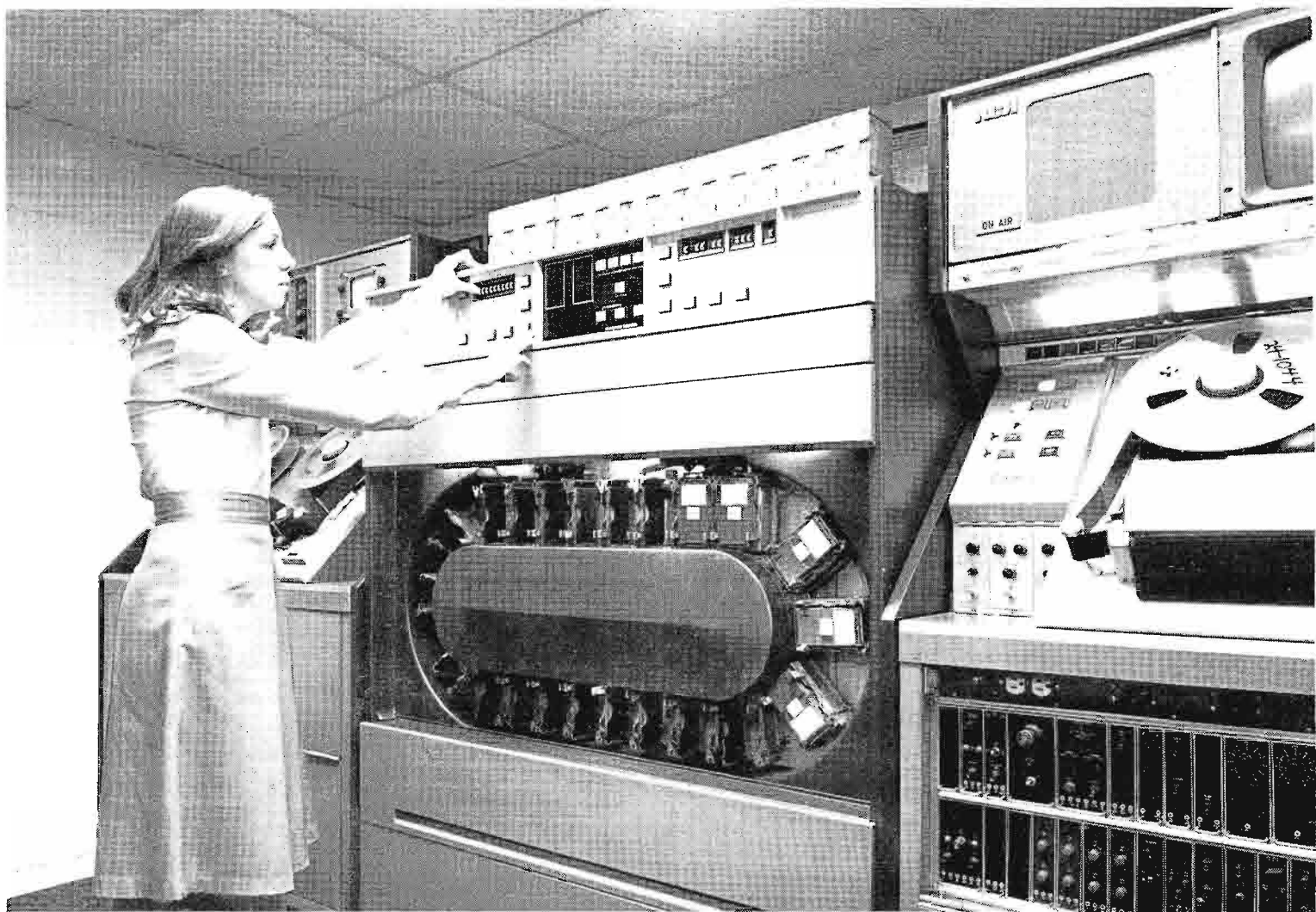



Channel 80's compact van leads a motorcade of 250 cars down the Champs-Élysées, last part of a mobile promotion picked up live for a Renault auto-dealers' convention in Paris.

mini MOBILE UNIT

Gives French TV Company All-Around Capability

PARIS

Imagine providing live TV pickups for a long-distance motorcade, or shooting far-flung location sequences, or covering a presidential visit on another continent, with minimum logistical efforts and a different point of view. That's the kind of flexibility RCA's mini-mobile unit is affording clients of Channel 80, a teleproduction company in La Garenne-Colombes just outside of Paris.

It purchased the unique van last year to complement its studio facilities. In doing so, the company expanded its overall production capability and, at the same time, introduced a new style and technique into its video expertise.

Designed and built by RCA Jersey Limited, Jersey, Channel Islands, the nimble, little van permits unusual angles of view for shooting while in motion. To work beyond the van, the cable supply allows operation up to 300 ft. away so the cameraman can really get inside the scene and capture the essence of what's happening.

This mobile production unit features the famous Range-Rover chassis, and provides everything needed for originating and recording broadcast-quality material.

Self-sufficient with a built-in motor generator, it contains a full complement of PAL equipment. There are two TKP-45's, the portable camera that's the foundation of a total system for work inside or outside the studio; an advanced technology TR-600 video tape recorder; audio, control and monitoring facilities; plus a SECAM standards converter.

Since delivery, the van has been on the move handling video assignments for a cross-section of customers—national and multi-national corporations, French television and foreign producers.

Because of the van's proven successes, Channel 80 recently bid for more location business throughout Europe by demonstrating it live at the recent Vidcom Convention in Cannes. Monitors in the company's stand in the exhibit hall showed live pictures from the TKP's shooting from the van parked outside.

This, however, only hints at the elaborate and extensive jobs it can do.

Rolling Motor Show

A case in point is the van's use for both real-time and recorded coverage of a spectacular promotional event for Renault, one of France's big auto-makers.

To introduce and promote a new model to its nationwide dealers, Renault came up with an innovative marketing strategy that exploited video's potential to its fullest. The result was a spectacular event for over 1000 dealers convened at the Maison de la Radio (French radio and TV headquarters) in Paris.

The key idea was a motorcade of some 250 of the new-model cars from the company's plant in Douai to Paris, about 120 miles away. Channel 80's mini-mobile unit covered the caravan's departure as well as its progress en route at four different locations.

The arrival of the motorized brigade in Paris couldn't have been more impressive as the massive pack—led by the Channel 80 van—rolled down the Champs-Élysées to the Esplanade des Invalides in the heart of the city.

From beginning to end, the 1000 convention participants watched the mobile event live on a life-sized TV projection screen which enhanced the immediacy and excitement of the video extravaganza. It was part of a four-hour program including other on-location presentations and pre-recorded materi-

al, such as dealer interviews, which were also produced with the mini-mobile unit. The final pièce de résistance was each dealer's being given one of the cars from the moving phalanx at the end of the convention.

The TKP's operating convenience, and the van's design concept, were well suited to the now-or-never pictures involved in the promotional procession. The Renault assignment demonstrated just how fast and smooth the camera handles and how quickly it's ready for just about any demand made of it. In addition, the van's camera vantage points—through a hatch in the cab roof, on the roof of the van or on a rear platform—gave the cameraman a variety of options in angles of coverage not possible with big vans with studio cameras.

International Production

Another example of the van's facility and reliability in handling motion videography was its use for total coverage of French President Giscard d'Estaing's visit this past summer to Gabon in Africa. It also demonstrates the vehicle's, and the equipment's, operating reliability under adverse climatic conditions as characterized by Gabon's steamy equatorial temperatures.

Transport logistics were relatively simple. The Channel 80 van was driven to Le Bourget airport outside of Paris and then airlifted to Franceville in Gabon. TV coverage began right there at the airport when President Giscard d'Estaing arrived.

Run from the van, the two TKP's lensed the French President as he was greeted by Gabon's President Omar Bongo. Coverage continued as the van led the presidential convoy into Libreville about 16 miles away, where most of the activities—indoors and out—took place for eight days.

The official schedule of events included a press conference, theater events, state dinners, visits to industrial facilities, signing of agreements between the two countries, and, of course, the French president's departure.

The TV coverage was arranged by France Regions 3 with Gabonese TV in Libreville where, incidentally, the tapes were edited in conjunction with the TR-600 in the van.

An On-the-Spot Interview

Further evidence of the van's versatility is the outdoor location work Channel

80 handled for Syd Vinnedge Productions, Inc. of Los Angeles, California. NBC engaged this U.S. production company to obtain a location sequence for an entertainment documentary called, "Friends".

Channel 80 was recommended to Syd Vinnedge Productions by an executive with another U. S. network which used the same compact video van for frequent and various sports pickups in Europe. The network executive said that the equipment and crew were excellent.

For the NBC sequence, the Channel 80 van was deployed to Cap d'Antibes on the French Riviera where it shot a taped interview of Lindsay Wagner, star of the popular U. S. TV show, "The Bionic Woman".

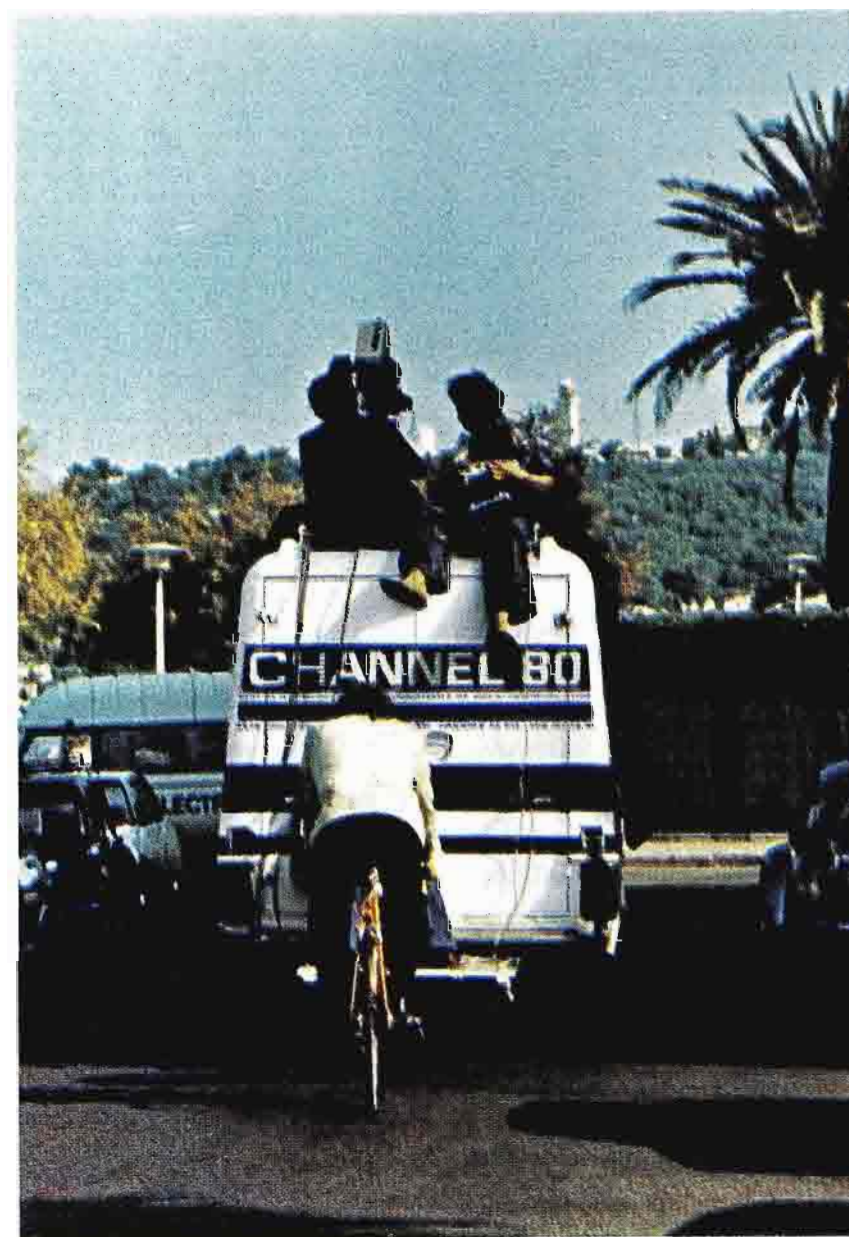

With in-board generator running, mini-mobile unit arrives at Cap d'Antibes location ready to shoot a sequence for an NBC documentary.

The sequence, recorded on the PAL 625-line standard, was converted NTSC. Joe Byrne, producer for this Syd Vin-nedge segment, asserted that the quality of the video tapes was excellent. "When we were editing," he said, "many engineers complimented us on the quality of the pictures." The sequence was compatible in color resolution and quality with all the material recorded for the documentary.

Created Images

Quality of production is also evident in the output of Channel 80's studios in La Garenne-Colombes. Commercials and discussion programs for French TV are among the material turned out there. However, most of Channel 80's work leans towards corporate communications and training programs. Besides Renault, Channel 80 has handled such productions for IBM, Honeywell Bull, Crédit Lyonnais Bank, Air France and Colgate Palmolive.

Beginning with training films when it was established just three years ago, Channel 80 made a quick transition to video. More and more clients were recognizing the merits of video tapes as an effective device for lecturing, demonstrating, illustrating and training.

The change-over was a natural progression, going from black and white to color a year and a half ago with a full complement of RCA broadcast equipment.

Studio production currently revolves around a complex of three camera studios, three VTR areas (one of which is used for editing), an audio control room and a master video-control room. The film room, as well as scenery and prop workshops, are in a separate building. A driveway, in which the van is parked when not out on assignment, separates the two buildings.

Audio control, which has visual contact with adjacent master control, overlooks the main studio to which Channel 80 recently added a third TK-45 camera.

Instruments of "Choice"

These cameras are full production units which afford sophisticated control and provide the high-quality image essential to the instructional medium.

Commenting on the cameras, Channel 80's Production Chief/Vision Manager, Mr. Lemaire, says he likes the TK-45's quality and definition of color.

Interestingly, Mr. Lemaire adds that,

by choice, he overrides the TK-45's automatic black balance and automatic iris. "I make my own adjustments to get exactly what I want."

The TK-45's perform well manually, allowing for special effects or lighting conditions that are just right for what Mr. Lemaire or a client's producer or director may have in mind for a particular production.

However, one automatic feature he doesn't manipulate is white balance because, whenever lighting or props are changed, the crew can carry on without any fuss.

Other production controls, at the CCU, are also used to produce the most desirable output. For example, Scene Contrast Compression is employed for scenes with high contrast or strong directional lighting.

Mr. Lemaire described such a scene in a sales-training tape for a lamp manufacturer. For a very dramatic effect, the customer wanted a lot of shadows on the lamp being introduced. However, it was important that certain details were visible. By stretching gamma, the Scene Contrast Compression feature lifted the details without affecting the highlight portions of the scene.



TK-45 shoots customer-dealer situation simulated in the studio for a Renault training tape.

Broadcast-quality production values also extend to the taping operations, supported mainly by one TR-600 for high-quality mastering and dubbing, and two TR-600's with Time Code Editing for refining the raw recordings. The editing facility is also used in conjunction with a chroma-key studio for inserting special backgrounds or graphics.

Another piece of equipment supporting Channel 80's basic philosophy of excellence is a TK-28 film island. When films have to be transferred to a 2-inch tape and then dubbed to cassettes, or inserted into a taped production with the switcher, the quality of the presentation is improved, or maintained. The TK-28's built-in correctional features are utilized to handle a wide range of picture -quality problems.

Mr. Lemaire considers them very important, especially white and black balance. Although they can operate automatically, he, again, prefers to adjust them himself to get the kind of results he—and Channel 80 clients—demand.

Channel 80's TK-28 is interfaced with a TP-7 35mm slide projector, a TP-66 16mm film projector and a 35mm film projector to accommodate a variety of film formats for any given production.

Progressive Video

As France's premier, independent video tape center, Channel 80 can handle a gamut of assignments in the studio or anywhere location shooting is needed.

This, of course, is gratifying to Channel 80 and its customers. But the significance goes deeper than that, because the company is providing a way to combine different media into an effective whole that satisfies a variety of growing communications tasks for the business audience. □

TK-28 island is used for transferring film to tape, and for inserting film material into video-taped productions.

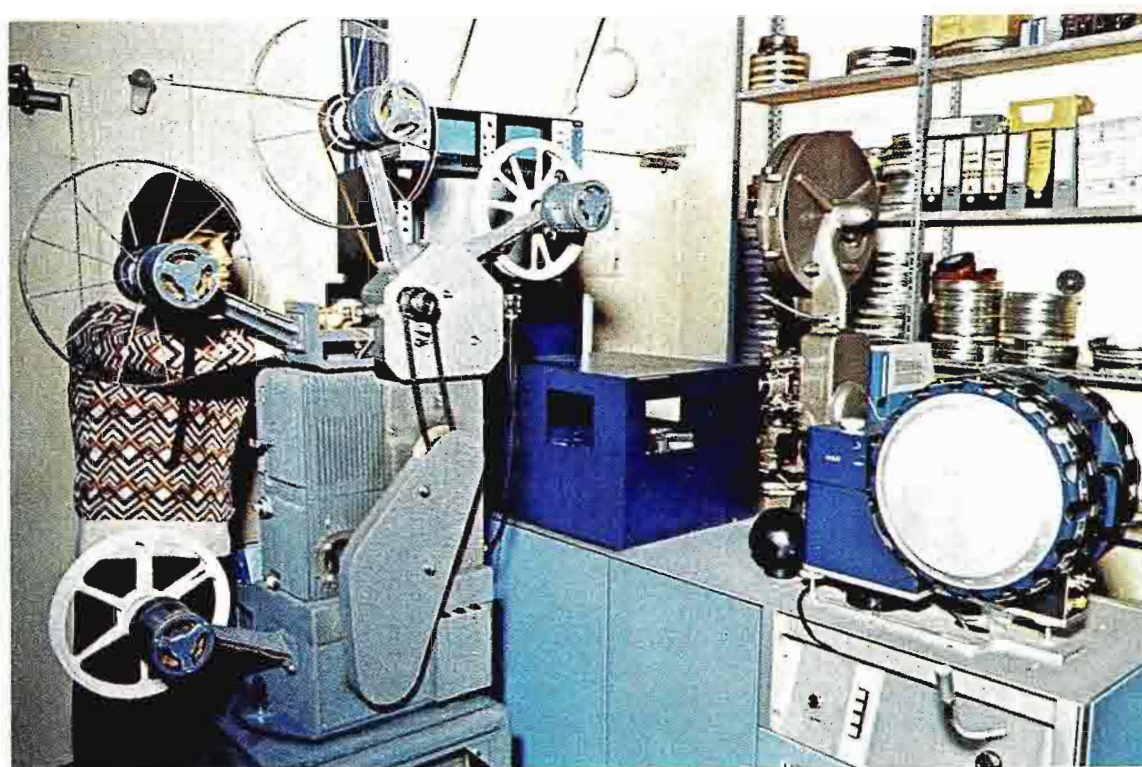

The tape complement includes four TR-600's, which include the two pictured here in the editing room.



Future Compatible Transmitting System for **WKYC-TV**

The track record for operation has been short, but the benefits of careful system planning are already being reaped. Although planning is basic to any major equipment purchase, Raymond (Ray) Smith, Director of Technical Operations for WKYC, places an added premium on it for transmitting systems. "They're complex, costly, and usually 'once-in-a-career' type purchases," he says.

Planning for the new transmitting system, as applied by Ray Smith and by Tom Miller, Supervisor of Transmitter/Remotes, was thorough. Among the major areas covered were:

- Analysis and documentation for management
- "Ground zero" checkout of existing system
- New transmitting system options and performance goals
- Environment — new air handling system
- Audio and video controls
- Remote Control System

As a part of the overall planning effort, pre-installation site preparation tasks were also carefully coordinated so the system installation went smoothly. All

electrical, mechanical and structural work was completed before the transmitter system components were moved into the building. A firm timetable and tight logistic controls solved most of the chronic construction and installation problems before they reached the critical stage. While this may seem obvious, Ray and Tom checked other new transmitting plants while planning the WKYC system, and found that preparing the site for the transmitter is one critical area where many installations falter.

Management Documentation

In-depth planning preceded installation by about 18 months, starting with a careful engineering analysis which resulted in a fully documented presentation to management. The transmitting plant investment was supported on the basis of an eight-year payout. Personnel savings were projected to come from more effective utilization of manpower, by the transfer of transmitter engineers to the studio. The management presentation also covered additional advantages of the new transmitting system: improved on-air signal; redundancy; automatic operation; reduced maintenance, and readiness for circularly polarized operation for the future.

Front line cabinets of TT-50FL, 50 kW transmitter at WKYC-TV are built-in to form a wall of the control area. Extending at right angles to the transmitter are the audio and video monitoring racks.

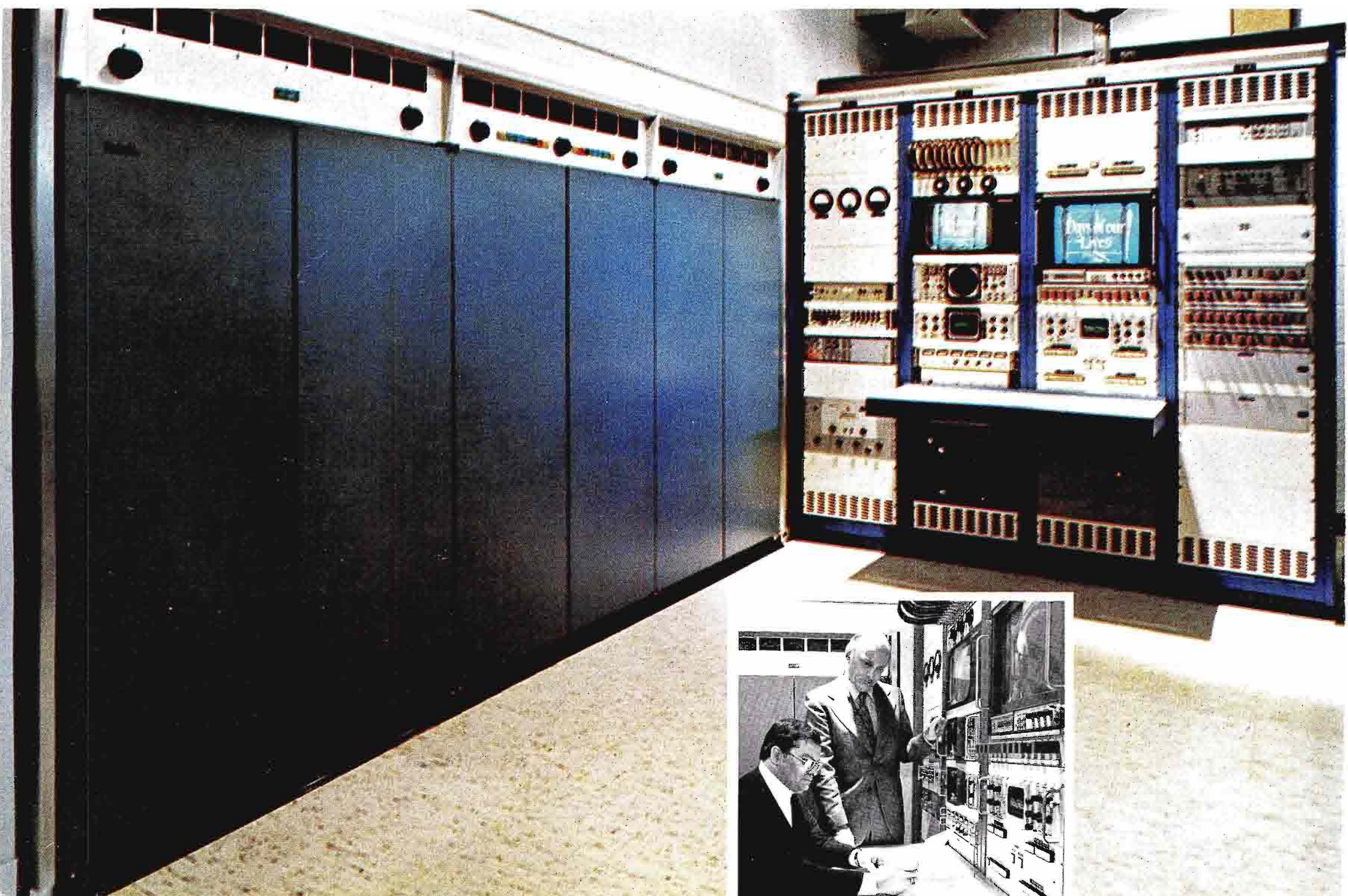

WKYC-TV transmitter building at Parma, Ohio.



Layout, WKYC-TV Transmitting facility.

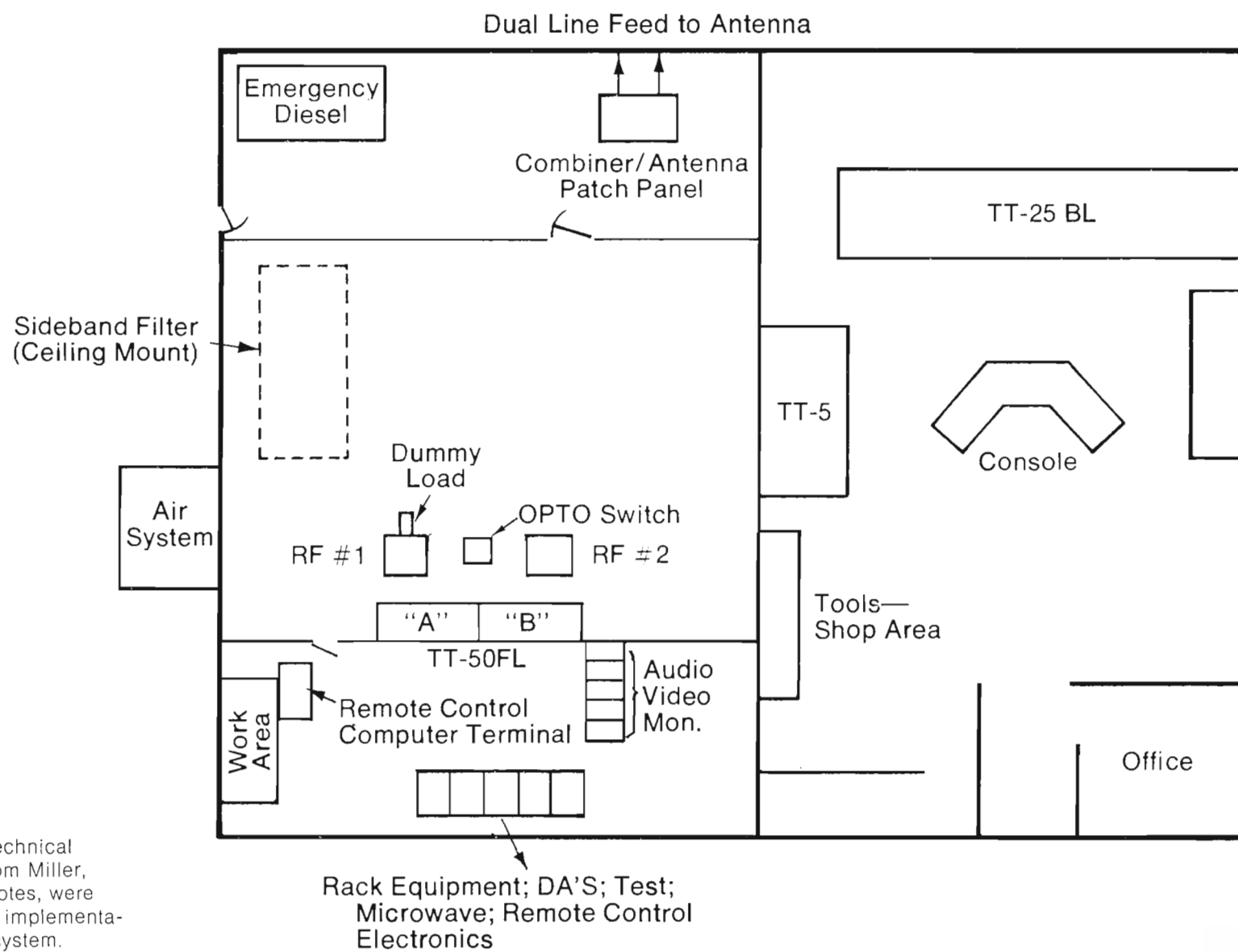

Inset: Ray Smith, Director, Technical Operations (standing) and Tom Miller, Supervisor, Transmitter/Remotes, were responsible for planning and implementation of the new transmitting system.

Plans for the new television transmitting plant accelerated when the AM radio station operated by WKYC was sold. This removed a large 50 kW transmitter from the transmitting building at Parma, Ohio, and opened up space for the new TV system. The operating transmitter for TV-3 was a 25 kW TT-25BLA which was installed in 1953. It had given excellent service, Tom Miller points out, but was aging and would need extensive updating for remote operation. At times when the main transmitter was down, it was necessary to operate with the even older TT-5 standby transmitter, with reduced performance.

Complete Input-to-Output Checkout

TV-3 engineers took a "ground zero" approach to the new system by first checking out the entire existing plant, from input to output. The total system inspection began at the top of the tower with the antenna, a 6 bay TT-6AL Superturnstile, since this was not being replaced. Flanges were checked and jumpers replaced. Tower transmission lines were DC pulsed and tested for leaks. Line impedances were plotted, and the total system performance was measured and documented. As a part of this comprehensive antenna system checkout, Tom Miller was able to simplify the transmission line layout substantially. On the tower, eight elbows were eliminated in the new system.

System Consideration

Future considerations played a large role in the WKYC transmitter plans. Ray Smith looked for a system which would go beyond Remote Control to one which would even function as an Automatic Transmitter System (ATS) when this mode is approved by the FCC.

"There is a crying need today," Mr. Smith says, "for better overall designed transmitting systems—with built-in reliability and redundancy and which require less technical care and attention.

"Simplification is important, and 'gadgets' should be limited or eliminated. Our concept is that the system should include the least number of pieces and components needed to accomplish the job. It should be designed as a total system—as one large black box."

Accommodating the desired functional simplicity of the system and the capability for automatic operation was the heart of the planning effort. Involved

were numerous visits to other installations, followed by "on purpose" applying engineering to derive a system tailored to TV-3's immediate and future needs.

The new WKYC-TV transmitting plant included these major elements:

- Optimized TT-50FL Transmitter
- Ceiling-mounted Sideband Filter
- 3 dB Coupler Hybrid Combiner
- DCS-2 Computerized Remote Control System
- Dual STL Microwave System

New 50 ohm transmission line was also installed from the transmitter to the antenna gas stop. As noted previously, the antenna and tower transmission line were thoroughly checked and refurbished.

Transmitter System Flexibility

Since TV-3 operates its transmitter at 21 kW peak visual power, the new system had to be capable of at least 25 kW output. The options available included a single-end 25 kW system; a 30 kW parallel system, or a 50 kW parallel system. RCA's new TT-50FL 50 kW transmitter was selected because it offered the most in positive advantages.

Although the 50 kW parallel system was new, the "FL" design had established an excellent performance record in the field, and was capable of automatic operation. The parallel system provided flexibility for several operating modes which would be remote controlled from the studio. The transmitter is designed to require a minimum of manipulation by operating personnel. Many of the usual adjustments have been eliminated, on the theory that if there is no knob to turn, it cannot be misadjusted. Or, as Mr. Smith puts it, with fewer controls, the transmitter is less likely to suffer from "screwdriver drift".

The transmitter visual carrier frequency is rubidium controlled for precise frequency operation.

The TT-50FL is essentially two single 25 kW transmitters, so each side can provide enough power to meet the station's 21 kW visual peak output, with ample headroom. This permits Alternate-Main operation as an option, a convenient mode for maintenance, since each transmitter side is a mirror image of its mate.

Parallel Operation Enhances Performance

At WKYC, the system normally operates with both transmitters in parallel, each operating conservatively at less than half of rated power. Tom Miller reports that this mode provides a significant improvement in technical performance. It eliminates antenna ghosts and reflections, and provides a better on-air picture. Antenna reflections due to icing or other conditions are cancelled out in the hybrid combiner reject load, and therefore do not affect transmitter performance. The system absorbs residual reflections from the antenna and from assorted RF components within the transmitter plant, such as from switches, harmonic filters, diplexer, filterplexer, and transmission line elbows and connections.

For more flexibility, WKYC opted for Bi-Level Switching, which permits selecting either transmitter side for operation at full rated power. The transmitter may be switched from parallel to single operation at full licensed full power output in less than 3 seconds, without need for adjusting or retuning. Automatic bi-level power switching permits the system to combine all of the advantages of Alternate-Main and parallel operating modes.

Rear of amplifier and control cabinets. Filters at bottom center are intakes for the two blowers which cool the entire transmitter. The room is air conditioned, with positive pressure to pull cool air through the transmitters.

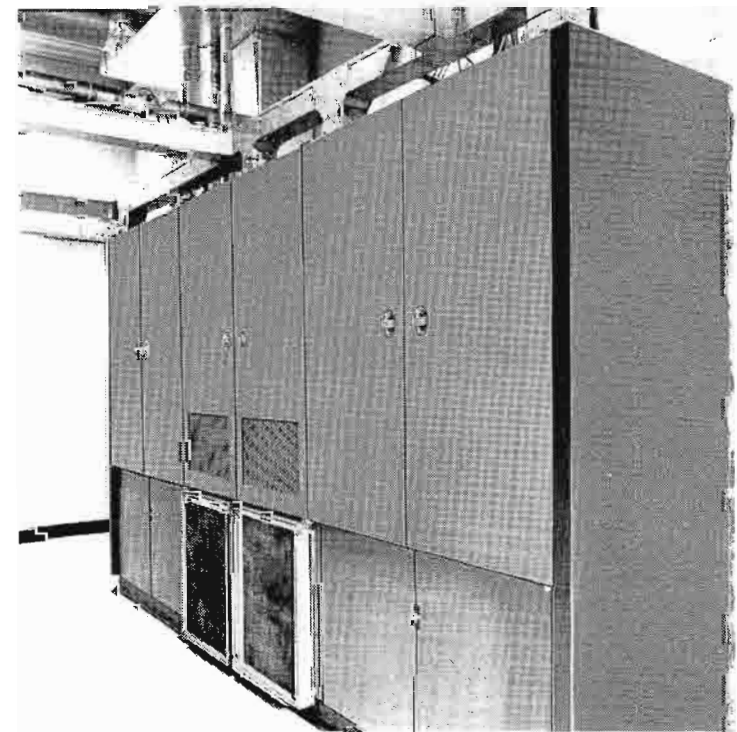

Front of
Opto-Switcher
cabinet, showing
manual patch panel.

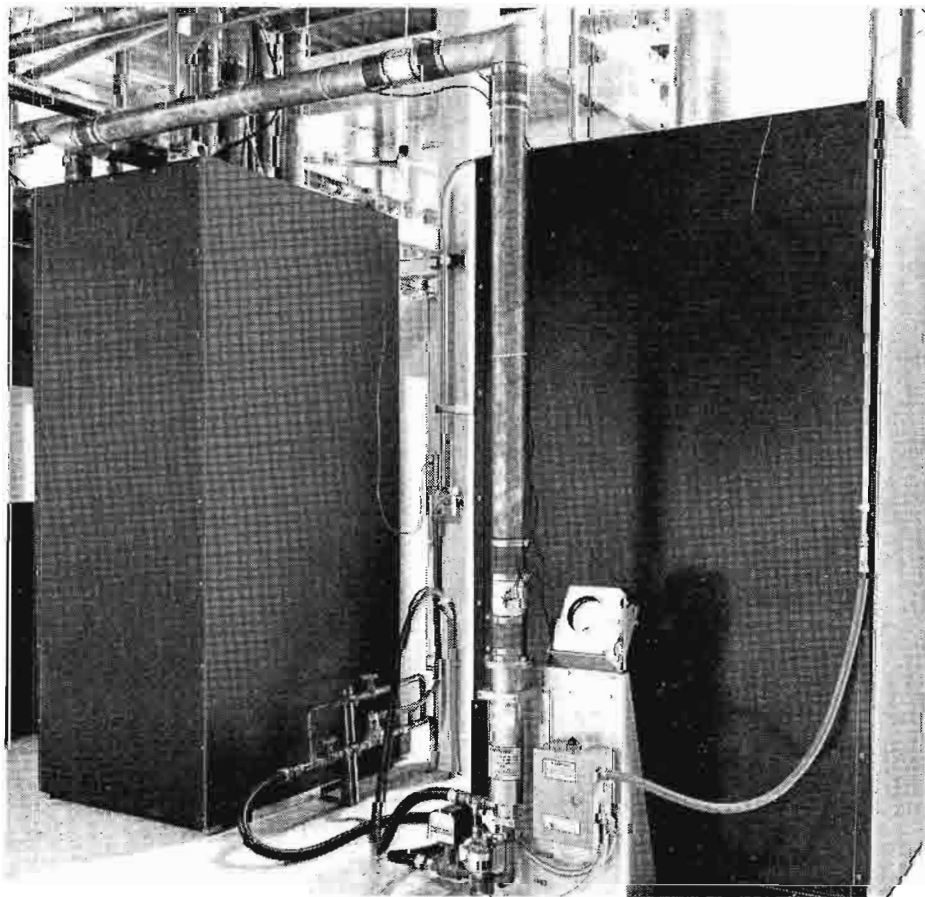
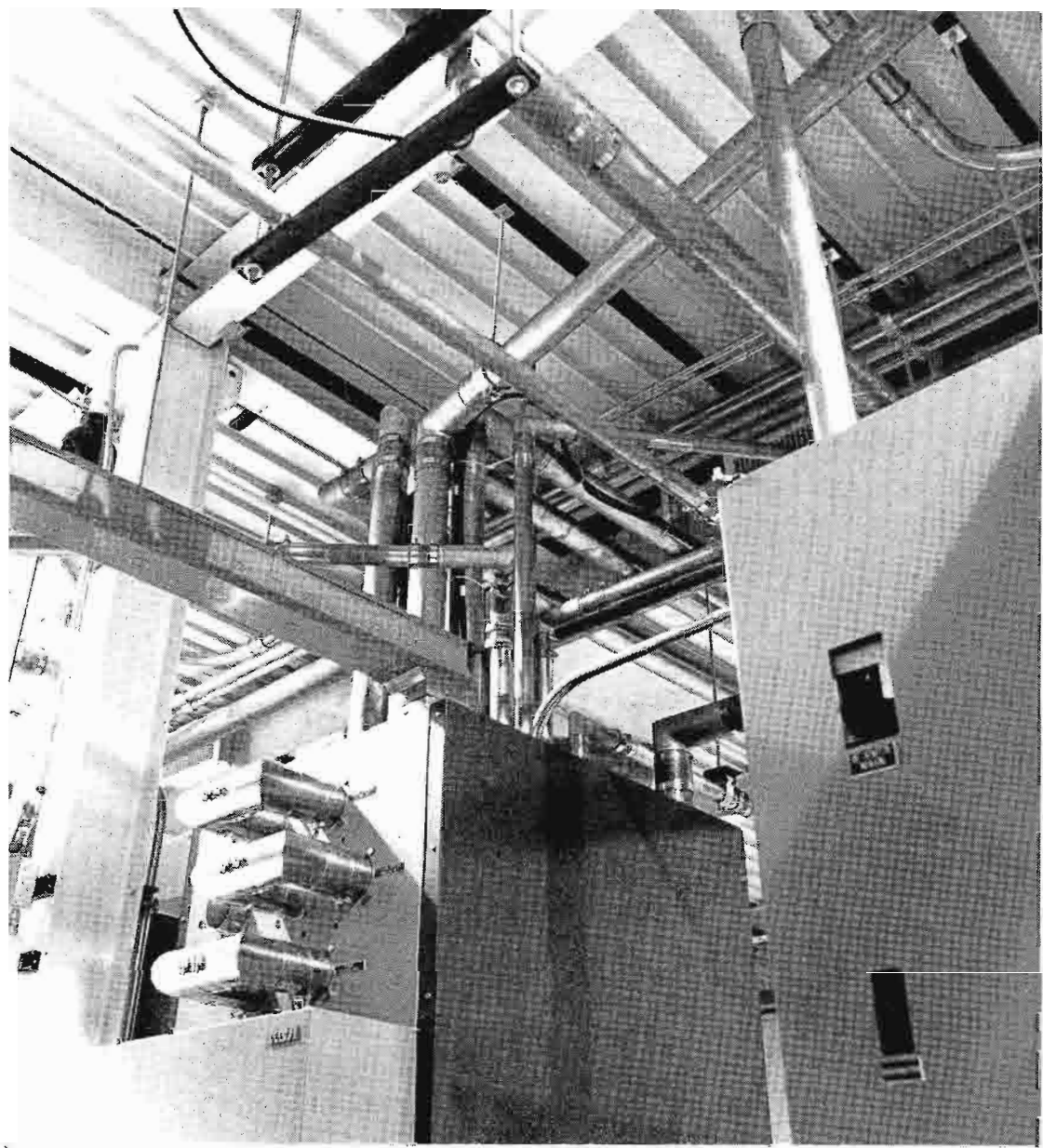

Rear of Opto-Switcher cabinet and one
power supply cabinet. 50 kW water-cooled
dummy load is positioned behind
the power supply cabinet.

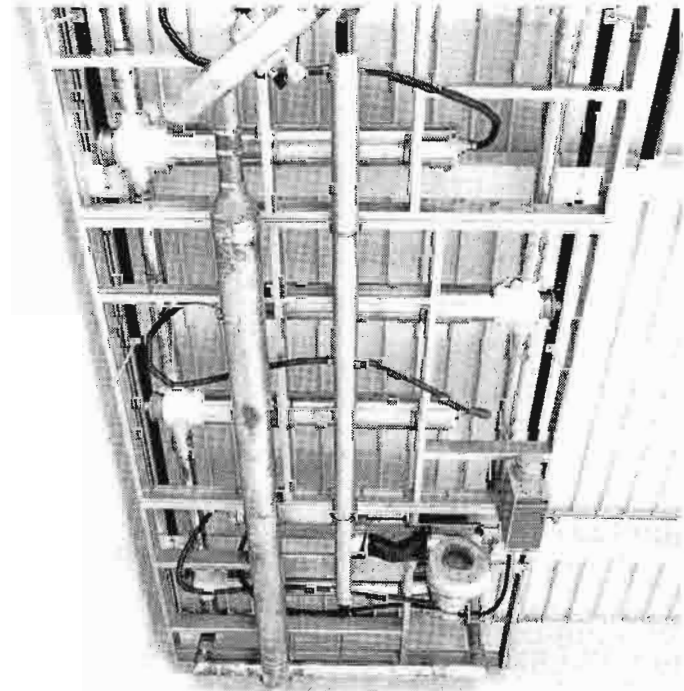

Ceiling-mounted 50 kW
vestigial sideband filter.

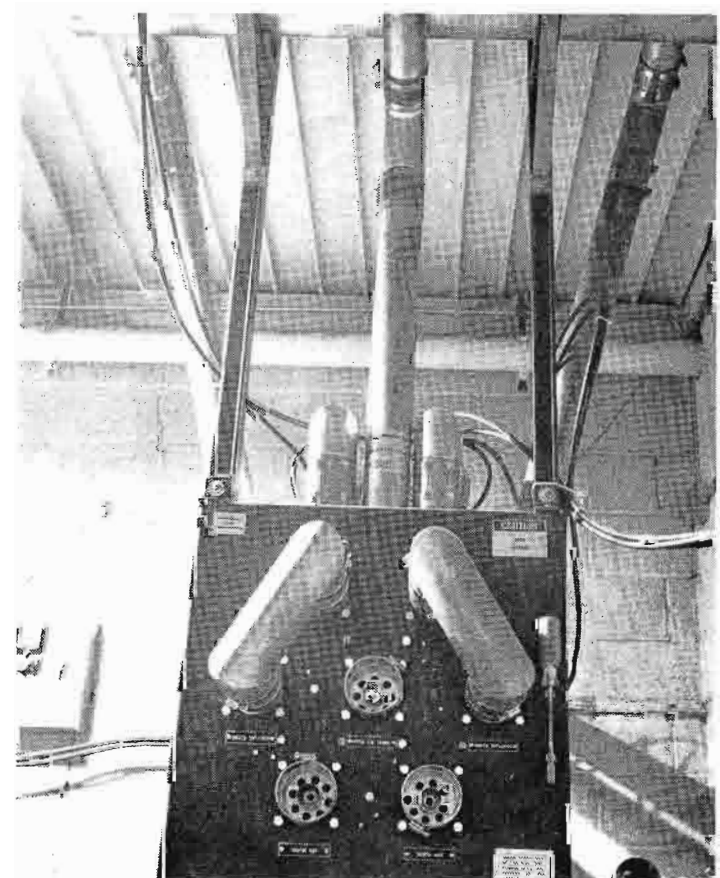

Antenna input patching, showing 50 kW,
3 dB Hybrid Coupler that combines
aural and visual and provides 90
degree phase shift for TT-6AL
Superturnstile Antenna.

Yet another advantage of the TT-50FL, according to Mr. Miller, is its higher power handling capability which provides enough reserve for circularly polarized operation as a future possibility.

An Optimized System

The TT-50FL at WKYC includes a factory-tuned OPTO-Switcher which is mounted in a separate cabinet between the two RF power supply cabinets. The OPTO-Switcher contains the motorized switches, patch panel, paralleling combiners and assorted elbows and coaxial lines in which component reflections have been carefully balanced out on the specified channel. To further improve performance, the entire TV-3 R-F output distribution system was field optimized as a part of the installation procedure for optimum VSWR across the channel.

The two transmitters tune identically, and when sweeping the antenna, there is no noticeable difference between going on dummy load or on-air. The optimized operation takes the guess work out of the system and makes for easier maintenance and troubleshooting, Tom Miller says.

New Sideband Filter and Combiner

The new sideband filter for the TT-50FL is hung from the ceiling to the rear and to one side of the transmitters. This allows the location of the harmonic filters almost in a direct line between the OPTO-Switcher output and the sideband filter input. A new run of outside line from the existing trestle was required to enter the transmitter building near the 3 dB coupler which is located just inside the wall. There is a dual line to the antenna.

Friendly Transmitter Environment

Some of the total system planning effort at TV-3 was directed toward providing a cool, clean, friendly environment for the transmitter. This involved isolating the transmitter area and installing a new air handling system. With this system, the transmitter is maintained in a stable air conditioned environment with a constant 70 degree temperature, controlled humidity, and a slightly positive air pressure which keeps the room dirt and dust-free.

The air conditioning unit is a 20-ton glycol-cooled system, with enough reserve to handle the additional heat load which would be required for a circular polarization. (Ample unused space is available for adding another transmitter.)

The cool air is pulled through the air filters at the rear of the transmitter cabinets, and ducted out at the top. Chilled water (Glycol) is used for cooling during warmer weather, with the inside air being re-cycled through the system. When outside temperature drops to 50 degrees, outside air is used for cooling instead of the chilled water.

The system is designed to maintain constant temperature by motor-driven dampers for intake and exhaust; by chilled water, and by an electric heating duct (which is used for heating as well as for drying out the air in the transmitter room).

To provide the controlled environment for the TT-50FL, WKYC isolated the room by walling it off from the area where the old TT-25BL and standby TT-5 transmitters were located. Further zoning was achieved by erecting a three-inch metal partition wall to enclose the front line cabinets of the transmitter so only the meters and front controls project into the terminal equipment area.

Terminal Equipment Room

The TV transmitter terminal equipment area is arranged to facilitate maintenance functions. The audio and video control racks are closest to the front line cabinets of the transmitter and extend at a right angle from one end of the TT-50FL. Audio and video functions are isolated, and the controls are clustered, with video at the left and audio on the right. The technician making circuit or module tests has a direct view of the waveform monitor, vectorscope and the transmitting system function controls. The system is set up for ease of maintenance, Tom Miller notes, and excellent monitoring facilities are provided, including a Tektronix 1440 Automatic Video Corrector.

Monitoring and program facilities are redundant, with the systems operating from different circuit breakers and different AC lines for added protection against outages.

State-of-art monitor and test equipment are required, Mr. Miller acknowledges, because the performance characteristics of new transmitters such as the TT-50FL are so much better than earlier generation systems that some older test equipment does not have the sensitivity needed for accurate measurement. For example, he says, the audio distortion of the TT-50FL has been measured at 0.13%, with noise at -74 dB.

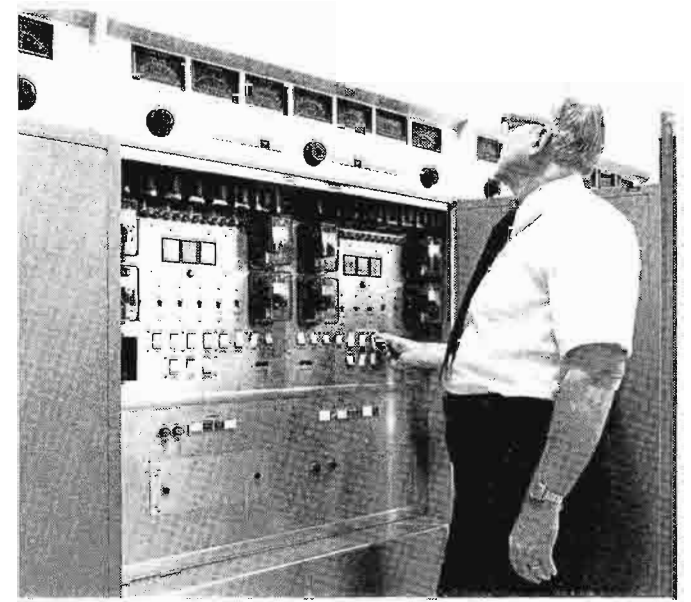

At the combined control cabinet of the TT-50FL is Kirk (Sandy) Sanderson, Transmitter Technical Director for WKYC-TV, who handled many of the system installation and check-out operations.

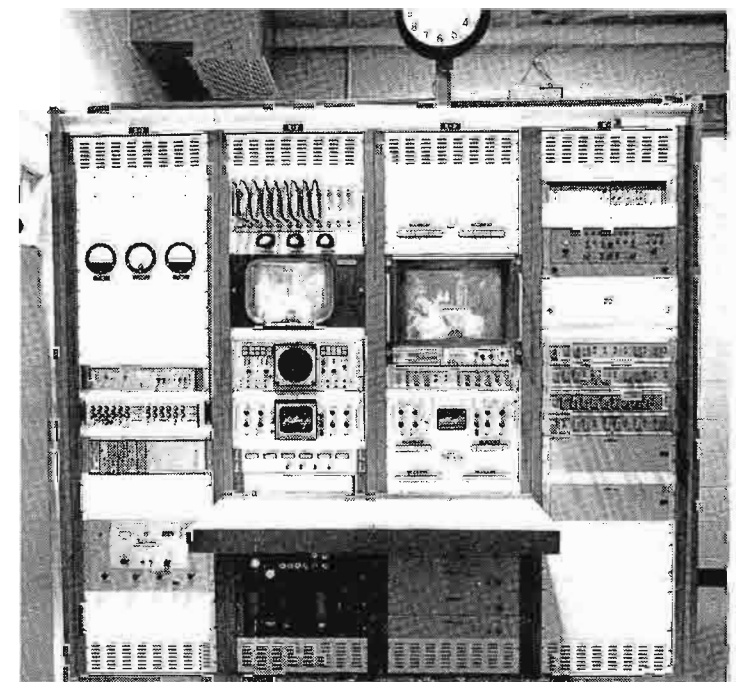

Audio and video terminal monitoring facility is set up for ease of transmitter maintenance. Controls are clustered, with video at left and audio on the right.

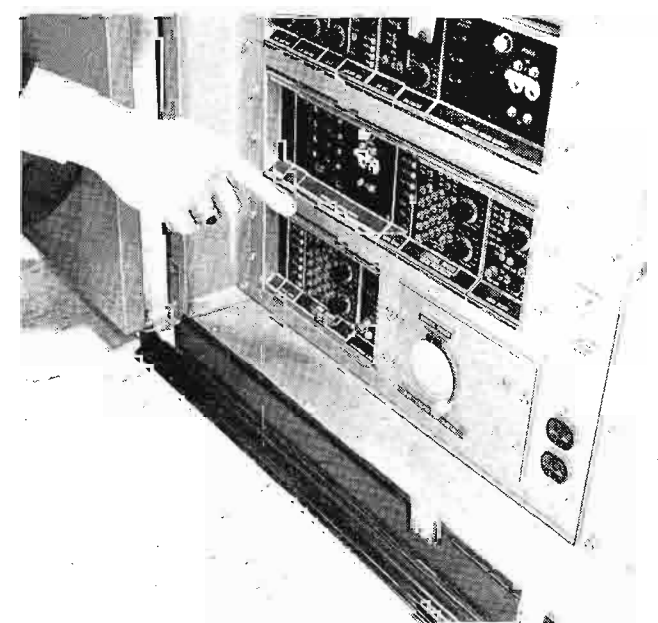

Close-up of Exciter, Video Processor and Automatic Bi-Level Switcher for one-half of the fully redundant TT-50FL.

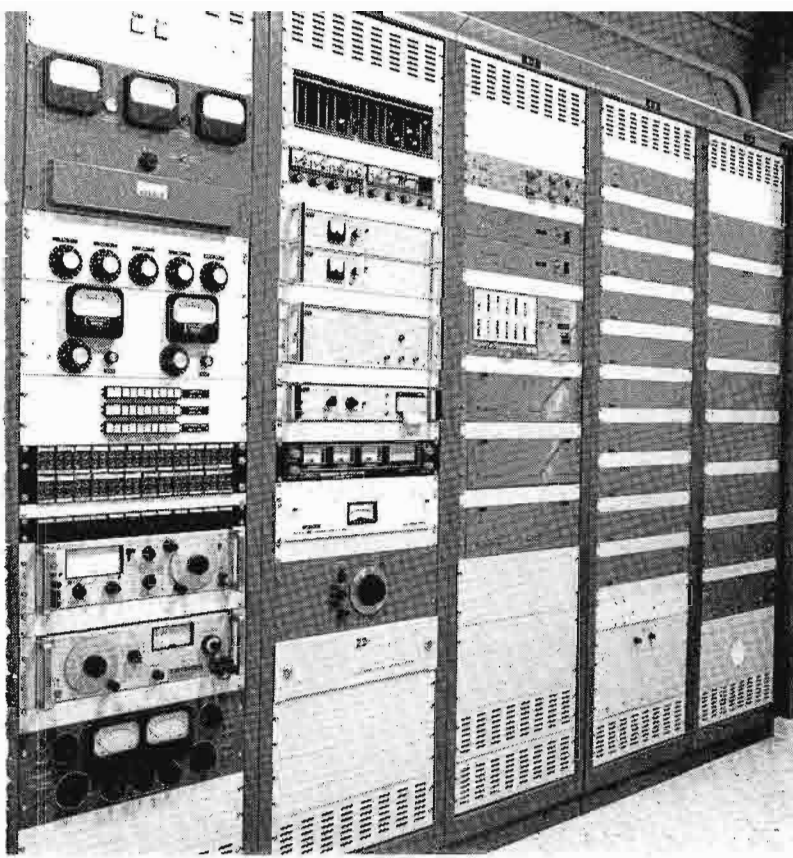

Monitoring, microwave, and remote control electronics racks in terminal control area.

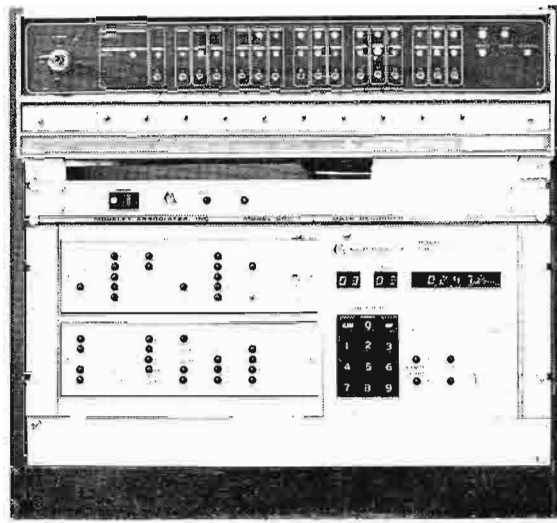

DCS-2 Digital Remote Control System studio unit, with computer processor panel, keyboard, digital display, and 60-channel Status Indicator.



Keyboard and CRT display unit for DCS-2 system located in the transmitter control area.

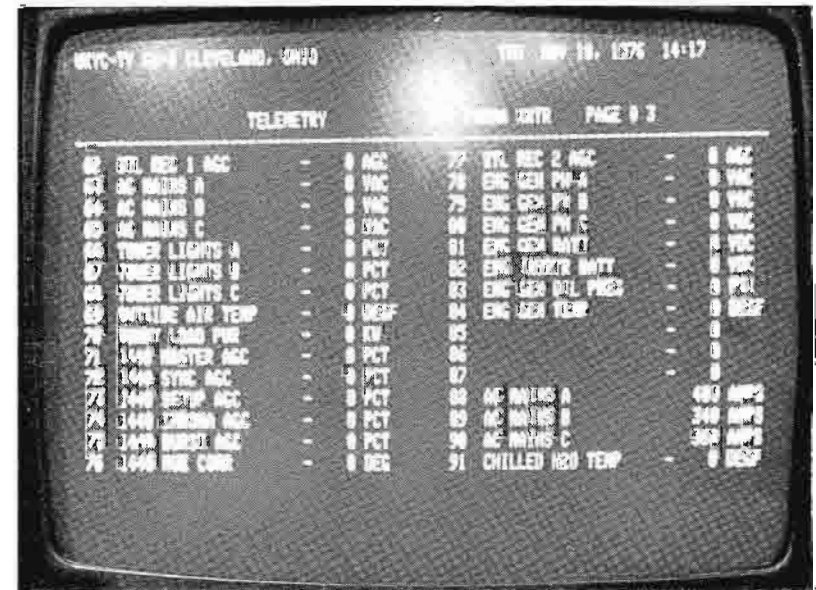
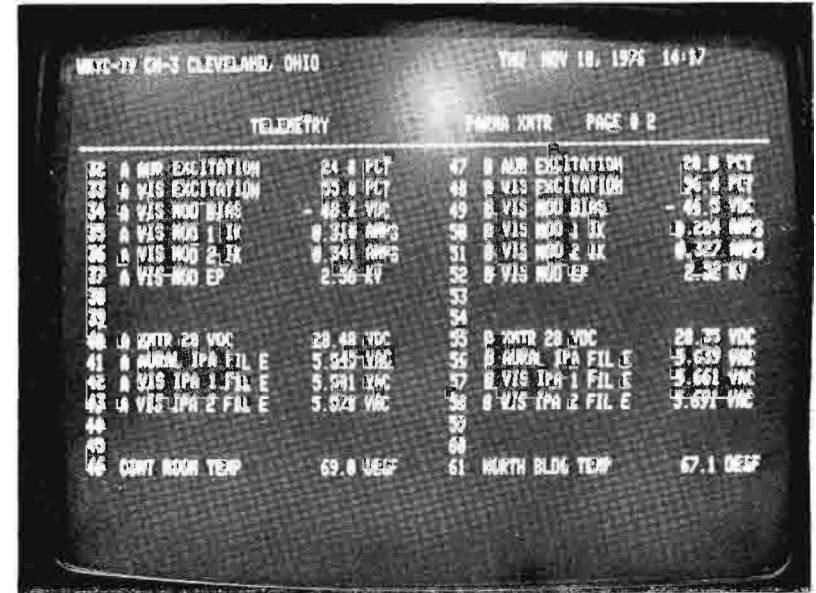
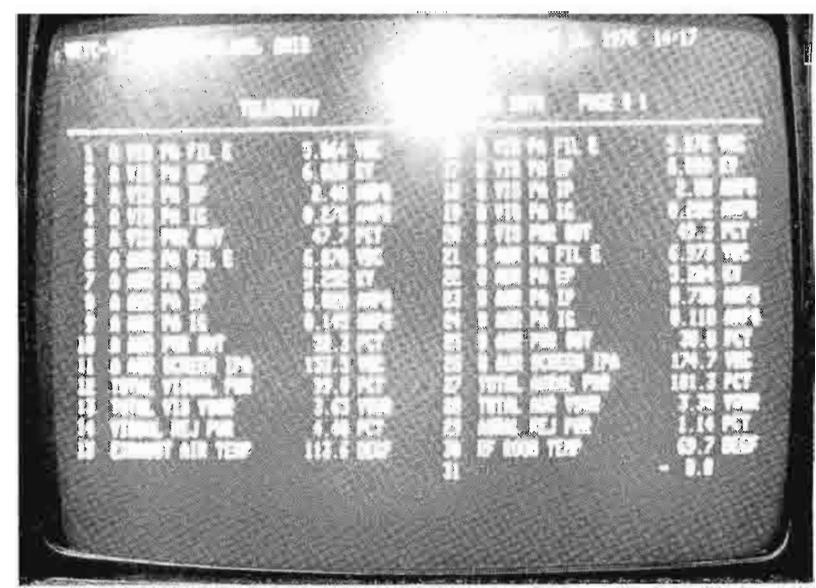

Computer-controlled system provides instant access to programmed transmitting system data. Telemetry, metering and numerous other system operating functions are available for display as "pages" on the video monitor.

Remote Control System

The plan for unattended operation of the TV-3 transmitter was an important factor in selecting the remote control system. A DCS-2 computerized system with 90 channel capability (or control for up to 180 On/Off; Raise/Lower functions) offered the flexibility to meet present and projected needs. With the computer-controlled DCS-2, system operation can be changed by re-writing the "software" programs to cover new parameters or functions at any time.

Programs are displayed as "pages" on a video monitor, with up to 30 items covering a "page". At WKYC, the "Page 1" readout covers major telemetry data for the "A" and "B" sides of the TT-50FL transmitter—including power level; plate voltage; plate current; exhaust temperature; etc. "Page 2" covers additional metering information on transmitter functions, such as excitation levels, IPA Bias, IPA Currents. "Page 3" expands the scope, covering such functions as AC Line Voltages, Currents, Emergency Generator Voltages, room temperatures; chilled water temperature, etc. Other "pages" display permanently programmed status messages and control function descriptions—and the end is not nearly in sight, according to Ray Smith.

As now programmed, the system provides instant access to more data than was considered possible—or even necessary—a short time ago. For example,

Tom Miller notes this application of the system: by routinely recording readings on tube operation, variations can be plotted to determine tube aging patterns and to check for degradation in performance.

A separate panel for the Remote Control System indicates—by lighted display—the status of 60 system functions. This panel, duplicated at the studio and in the transmitter control room, gives positive visual indication of system status.

A new microwave system installed as a part of the transmitter remote control system, is really two systems with the transmitters operating in parallel and with the receivers in diversity.

Planning Payoff: Excellent System Performance

Because of the extensive system pre-planning, switching from the old transmitter to the new one was a simple operation—a matter of changing the patches to the antenna. The long-running 1953 model TT-25BLA was shut down at sign-off the morning of September 30, 1976. Three hours later, the new TT-50FL parallel system was on to begin the new broadcast day.

The benefits of total system planning are reflected in part by system performance. Proof of performance measurements made by WKYC yielded impressive results. Combined aural transmitter AM noise measured -62 to -64 dB differential gain measured under 1%; differential phase less than 1°. Picture-captions of some WKYC-TV proof measurements have been included on the following two pages.

Although the day of the Automatic Transmitting System has not yet arrived officially, TV-3, Cleveland, has planned for it—and is ready with a future-compatible system. □

WKYC-TV PERFORMANCE PROOFS

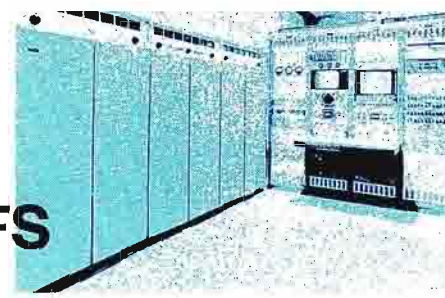

Sideband Response—Combined TT-50FL Transmitter Output Terminated in Station Load

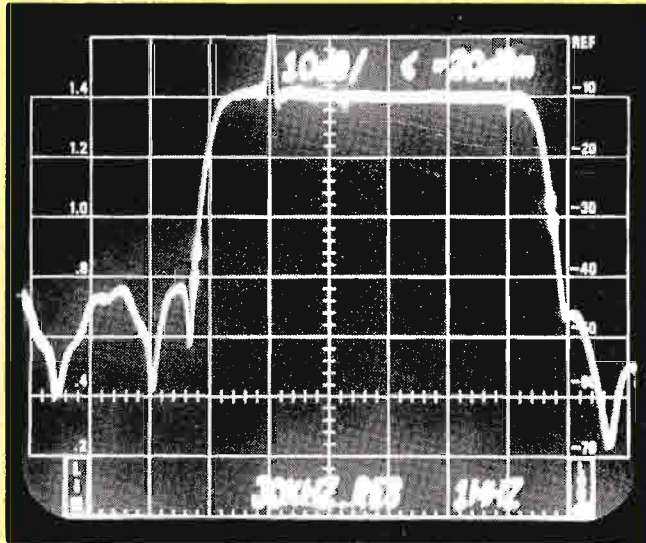

10 dB/vertical division

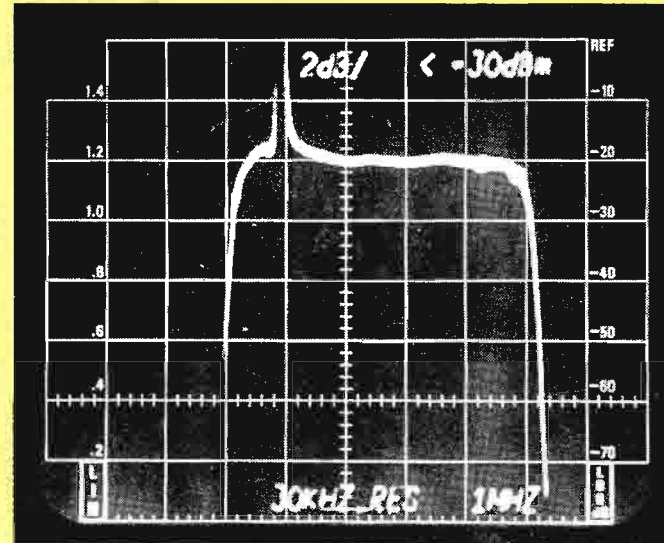

2 dB/vertical division

NOTE: Sample at VSBF output into Tektronix 7L12 Spectrum Analyzer and 1405 Sideband Analyzer. Markers 0.75; 1.25; 4.18, and 4.75 MHz. Input signal was composite video sweep from Tektronix 1405 (20 units of sweep, 40 units of sync, 50 units of pedestal), and Datatek D-701 low pass filter.

Transmitter Linearity—Combined TT-50FL Transmitter Output

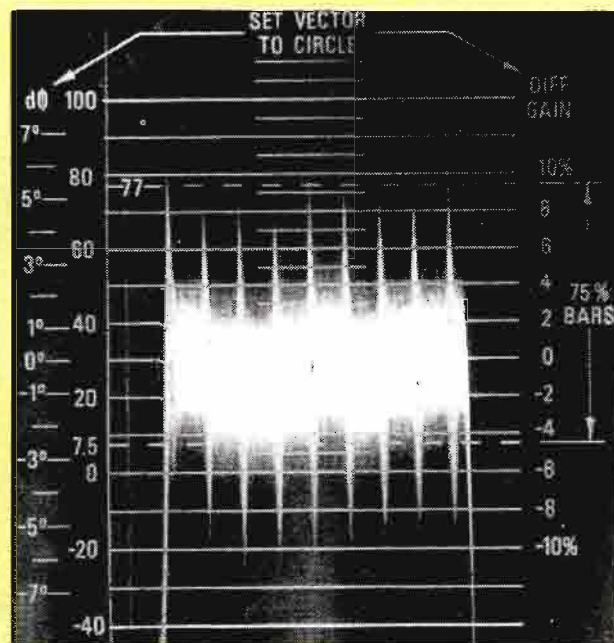

Differential Gain

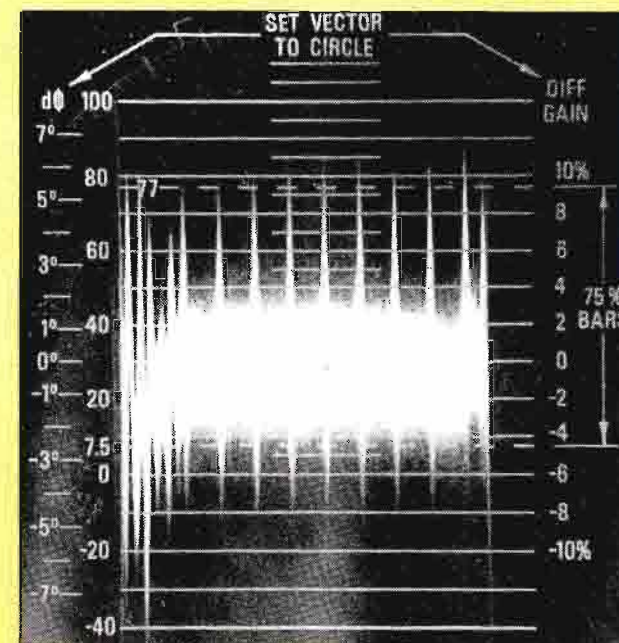

Differential Phase

NOTE: Sample at VSBF output feeding into Telemet 4501 Demodulator and Tektronix 520 Vectorscope. Input signal was 50% APL stairstep from Telemet 3508 Signal Generator. Modulation at 12.5% luminance and 75% pedestal; 3.58 MHz set at 20 units.

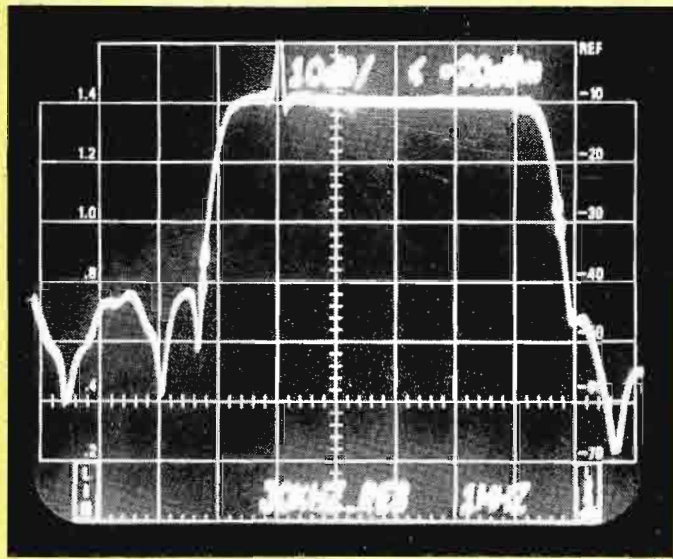

Parallel 25 kW Amplifiers
A & B Combined

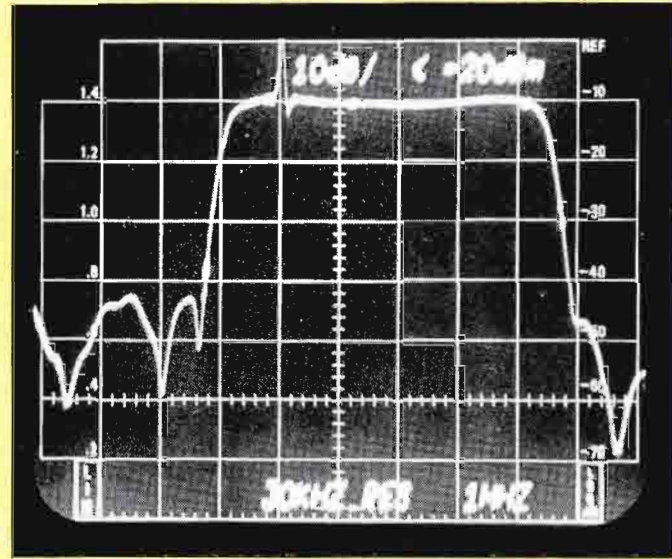

"A" Transmitter only, 100% Power

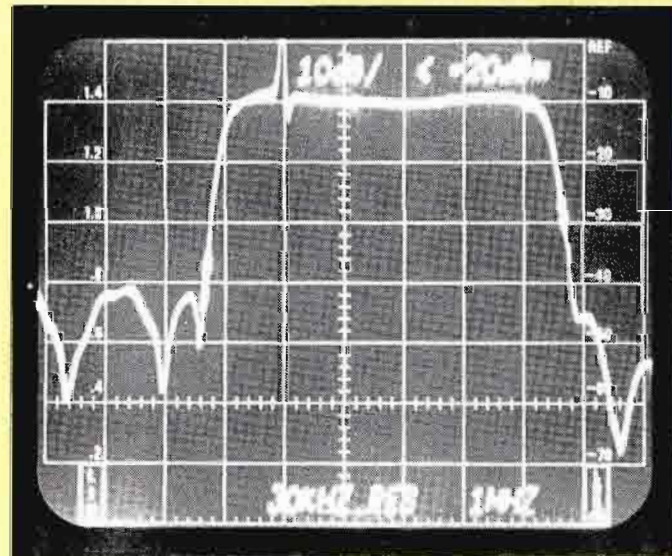

"B" Transmitter only, 100% Power

OPTO-Switcher Response

VSBF output terminated in station load, with parallel or single transmitter operation, showing response of optimized output system after mode switching and automatic Bi-Level power change without retuning or adjustment.

NOTE: Sample at VSBF output feeding into Tektronix 7L12 Spectrum Analyzer and 1405 Sideband Analyzer. Horizontal scale 1 MHz/division; markers 0.75; 1.25; 4.18, and 4.75 MHz. Vertical scale 10 dB/division. Input signal was composite video sweep from Tektronix 1405 (20 units of sweep, 40 units of sync, 50 units of pedestal) and Datatek D-701 low pass filter.

Variation in Output— Combined TT-50FL Transmitter Output

Sample at VSBF output feeding into Telemet 4501 Demodulator and Tektronix 529 Waveform Monitor. Signal is sync and window from Telemet 3508 Signal Generator.

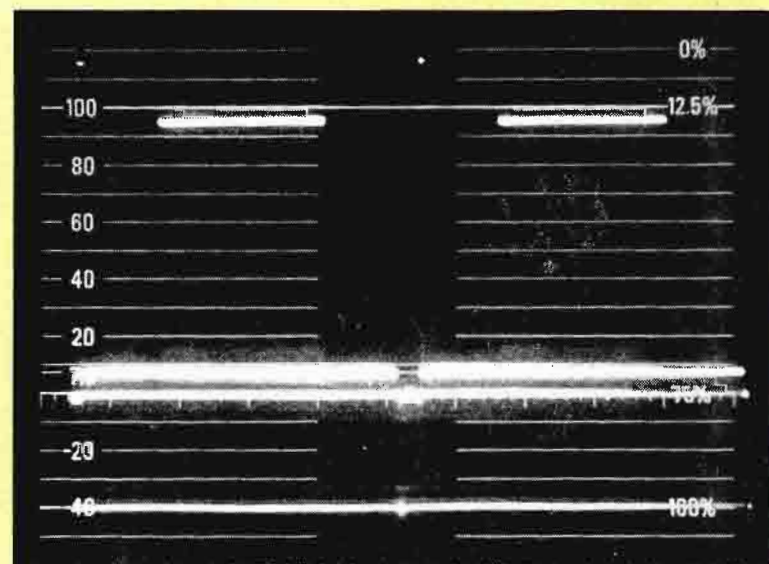

System Transient Response

Including STL Microwave link, Datatek D-701 Equalizer/filter, TT-50FL Transmitter with VSBF, and Telemet Demodulator (with sound notch switched out).

Sample at VSBF output feeding into Telemet 4501 Demodulator and Tektronix 529 Waveform Monitor. Composite signal is inserted by Tektronix R149A generator at studio.

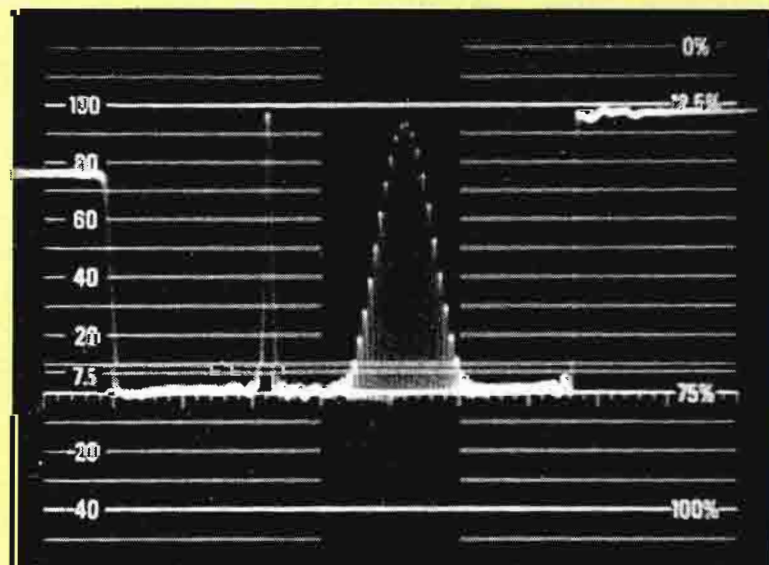



Chief Engineer Pat Howley operates TR-600's in Merrill Lynch video production facility. Quad machines are used for mastering, with edited tapes dubbed to videocassette format for distribution.



Merrill Lynch Video Network

Investing in TV for Effective Communications

Spacious Production Control area adjoins the studio and is usually a three-person operation, with video switching being handled by the Director.



MERRILL Lynch Pierce Fenner & Smith Inc., the world's largest securities company, is confronted with a major communications problem. With over 18,000 employees, a network of 225 U. S. branch offices, and operating in a dynamic, highly regulated and competitive industry, the need for fast and effective information exchange is essential.

To cope with this situation, Merrill Lynch's management turned to television several years ago. They experimented and tested both in-house and outside resources and evaluated results. Then, with a well-defined picture of how television could meet their communications needs, in 1975 the company expanded its Audio Visual Center staff and upgraded the existing TV system to broadcast quality with the addition of three TK-44B color studio cameras and two TR-600 video tape recorders.

The Audio Visual Center operates from the 30th floor of the towering new 54-floor Merrill Lynch headquarters building in the heart of New York's financial district. The Center, a spacious, well-equipped resource facility, was set up in 1969. Its first manager was Lee Ro-

selle who is now Assistant Vice President and Promotion Services Manager. The AV Center is one of a number of sections in the Promotion Services unit, which, in turn, is part of the Advertising and Sales Promotion Department.

The present manager of the AV Center is Nathan Sambul, an articulate, vigorous, 30-year old dynamo who has assembled a youthful, versatile staff to meet the growing creative and technical requirements of the video operation. Although the Center is responsible for all audio-visual requirements, Mr. Sambul quickly notes that television is now the predominant medium. The staff of thirteen includes a four-man technical group and three full-time television directors. Chief Engineer Pat Howley supervises technical operations with a three-man crew.

Television Facilities

When the move was made to the new headquarters building, operating requirements for television were carefully planned, with ample space provided for immediate and projected needs.

The 45' x 45' studio utilizes the full 12-foot ceiling height for the lighting grid. Three TK-44B's fitted with prompter attachments comprise the studio camera complement. The cameras have been extremely dependable and produce excellent color, Mr. Howley confirms.

The adjoining Production Control Room looks in 'on the studio, with video control, video switching and audio positions in line—and uncramped. This area and the other equipment locations are equipped with computer flooring, so all cabling is accessible and yet out of the way. Voltage regulators are installed to accommodate power fluctuations that could affect video performance.

TV Distribution System

Behind Production Control is the TV Distribution Center. This "house" television distribution system permits sending video and audio programs to some 150 locations throughout the building. Up to eight video programs can be aired simultaneously, using the two quad tape machines; four U-matic cassette players, and two 1-inch tape machines.

The in-house system provides a two-way capability, so that television programs can be originated in many offices in the building and recorded on the TR-600's in the AV Center. A small portable TV system handles this requirement.

Also located in the TV distribution



Three TK-44 cameras are used for studio production.



Nathan Sambul, Manager of the Audio Visual Center, confers with staff. Emphasis is on television, with four to seven programs normally in various stages of production.

area are two telecine islands, each with a 16mm film projector and 35mm slide projector. These systems illustrate the AV Center's knack for utilizing available resources. The telecine color cameras came from the studio, having been replaced there by the TK-44's.

Video Tape Operations

Video tape operations are concentrated in a compact area, the two TR-600 VTR's positioned side-by-side, with bridge monitoring facilities. A U-matic cassette recorder is also installed here, along with rack-mounted monitor, Image Enhancer and Time Base Corrector, which permits dubbing up from the cassette to quad with acceptable results. The TR-600's were the right choice for his operation, Pat Howley affirms, and the machines have measured up to ex-

pectations. They perform well and are easy to operate and maintain. The drop-on reel loading and straight line threading have been helpful operating conveniences. Furthermore, he says, "The diagnostic light system is excellent. It saves time and effort by identifying any non-standard operating condition."

Other facilities of the AV Center include an audio recording studio; editing rooms, and a sizable multi-purpose screening room equipped with projection and television facilities. This is used by corporate executives for viewing new television film commercials and the video tape programs produced by the center. The room is also extensively used by the AV staff for "client" conference meetings. A monochrome TV



"House" TV distribution system permits sending up to eight video programs simultaneously to 150 locations throughout Merrill Lynch headquarters.



Telecine system was colorized by adapting the "live" cameras previously used in the studio.

system installed here is occasionally used in preliminary program development sessions for displaying graphics and testing different program approaches.

Varied Programming

Television programs developed at the AV Center fall into four general categories:

- *Product programs* that communicate marketing concepts, such as options, commodities, tax shelters and government securities

- *Management information programs*
- *Employee information programs*
- *Operations programs* which are developed for the numerous support services in the organization. Orientation programs fall into this category.

As a resource operation, the AV Center functions much like an advertising or public relations agency, servicing a large number of clients. Here, the "clients" are the various Merrill Lynch product line, marketing and operations managers.

Program Development

Programs generally start with a "client" approaching the center with a communications problem, although some new programs are initiated by the Center as the result of an on-going evaluation of distributed programs which uncovers unfilled information needs.

Since Account Executives form the basic sales structure for the diversified revenue-producing operations of Merrill Lynch, it is only natural that a major share of the programs produced at the center are addressed to this vital and widely scattered audience of approximately 5,000 employees.

"Our goal is to upgrade the knowledge base of our Account Executives so that the right service is presented to the right customer," observes Mr. Sambul.

In handling production assignments, Sambul notes that *content* is the first consideration. The message takes preference over such other factors as staging and effects.

The AV Center schedule normally shows from four to seven programs in the production cycle, with one new program being completed each week on average. For most productions, company personnel—product line managers or marketing specialists—provide the camera talent. Creative graphics, pacing, direction and editing by the AV Center staff make even the data-heavy presentations easier to grasp.

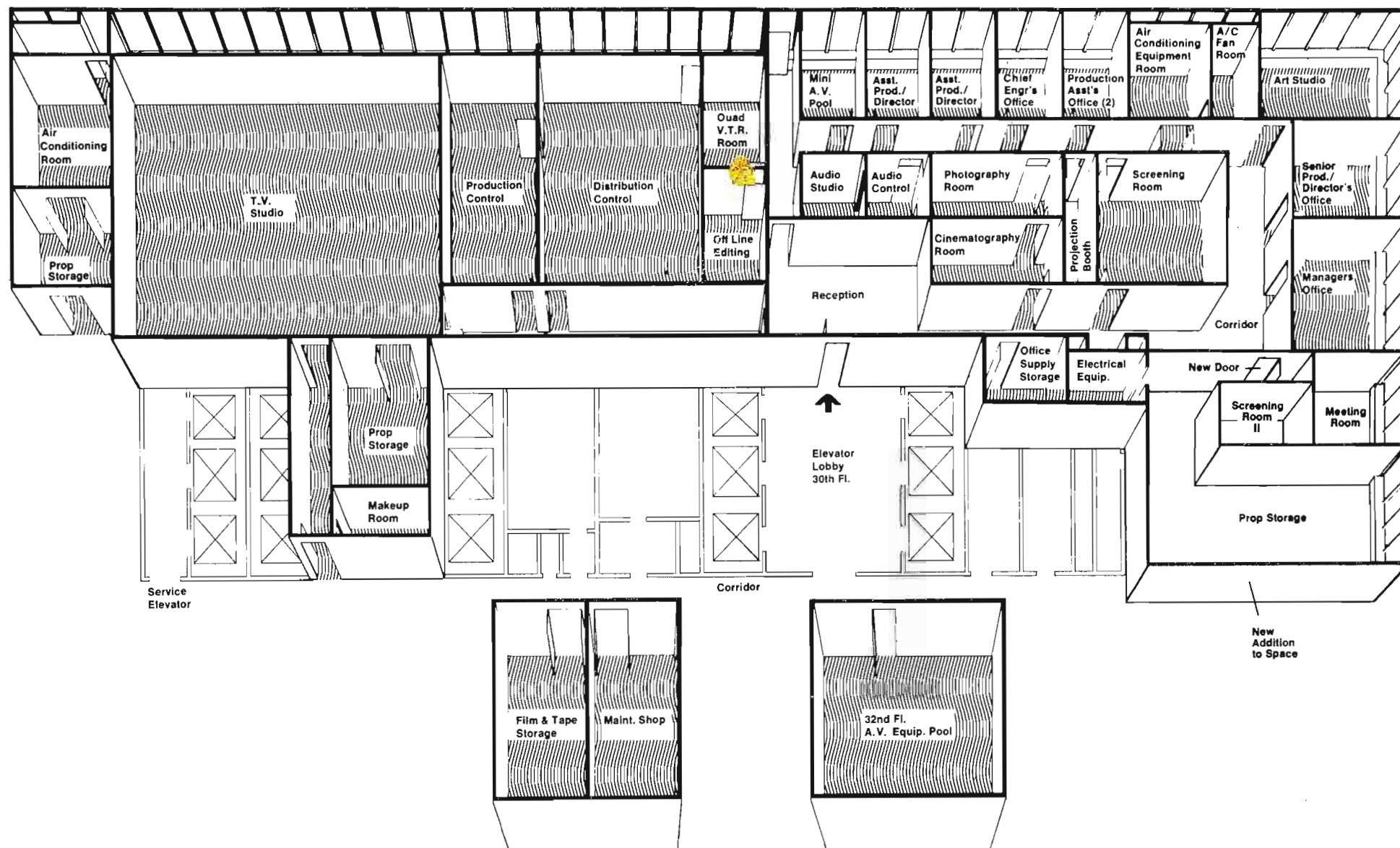

Layout, Merrill Lynch Audio Visual Center.

When the communications objective calls for it, the Center rolls out the full scale productions, complete with special sets, effects, and utilizing outside professionals if needed. One such widely acclaimed and award-winning production was "Error Reduction" which took its format from commercial television quiz shows.

Outside recognition for the quality programming produced by the Merrill Lynch Audio Visual Center has come in the form of numerous industry awards, the most recent being a Bronze "Hugo" and a Silver Plaque at the 1976 Chicago International Film Festival for two video tape productions.

In-House Production and Post-Production
Production and post-production are done at the center, with overloads being assigned to outside teleproduction firms. For studio-originated productions, three tapes are made: two on the TR-600's and one on a cassette recorder. This cassette tape is used with a 2850 off-line editing system for making rough edits. The final edit is done on the quad machines. The TR-600's are ideal for editing, according to Mr. Howley, be-

cause of their easy operation, fast lock-up and the ability to edit manually down to a frame. Master tapes produced on the machines are of superior quality, Mr. Howley notes. And, he adds, top quality masters are essential, since these tapes are used for dubbing to cassettes for distribution.

Two edited master tapes are made—one retained for backup, and the other sent out for duplication. The cassette dubs are distributed to more than 225 Merrill Lynch offices throughout the U. S. for local viewing. At the branches, the number of viewers ranges from five to 75.

Accent on Staff Training

Because of the complexities of the company's operations, program development demands close coordination between the AV staff and the product and market specialists. Mr. Sambul attributes much of the success in producing effective program material to the thorough company-sponsored training his staff has had in securities operations. This training enables the production group to acquire the expertise for understanding the "client" operations and

for translating their requirements into effective communications packages.

In addition to stockbroker training, frequent "inside" seminars are conducted by the AV staff and outside consultants on various technical areas of television production; lighting; make-up; set design; graphics, and camera techniques. Central to this emphasis on training is the AV Center's objective of producing quality programs:

- quality in content and presentation format
- quality as technical productions

Bullish on Television

Merrill Lynch's professional approach to meeting communications needs has proven its effectiveness within the organization. Management approval of the new studio equipment demonstrated its confidence in the competence of the Audio Visual Center, and in the importance of television as a corporate communications tool. Echoing the company's classic advertising theme line—Merrill Lynch is bullish on television. □

DIGITAL FUNDAMENTALS FOR THE BROADCASTER

Basic Logic Gates and Broadcast Applications

John W. Wentworth, *Manager, RCA Broadcast Technical Training*

The experienced broadcast engineer who has already lived through the conversion of television from monochrome to color; the advent of the transistor to replace the vacuum tube; the development of high-efficiency, remotely-controlled transmitters; and the introduction of sophisticated videotape editing systems should have no qualms about his ability to master the handful of concepts involved in digital technology.

The literature of digital technology is already voluminous, but the vast majority of the textbooks and magazine articles now available are oriented toward the needs of the equipment designer, not the user or the maintenance technician. Much of the available literature is also concerned with applications primarily in the fields of computers, digital communications, or industrial control, and is thus not too relevant for the broadcast specialist. Our objective here will be to help the broadcaster to understand the digital aspects of current equipment already designed by RCA and other major manufacturers in the broadcast equipment field. We shall not attempt to cover here the field of *logic design*, which is concerned with the transformation of design ideas into hardware. It is one thing to be able to read and interpret properly a logic diagram for a piece of equipment known to be capable of working effectively; it is something else to be able to create such a diagram beginning only with abstractions.

Basic Characteristics of Digital Circuits and Systems

The basic characteristic of all digital circuits that distinguish them from analog circuits is that only two steady-state levels are allowed at all inputs and outputs. This, in itself, is certainly not a new concept for the broadcast engineer, since nearly all types of broadcast equipment include control circuits for such purposes as the application of power, the operation of tally or indicator lamps, the delegation of remote versus local control, and the use of interlocks for personnel safety or the control of critical sequences. You may

not have been trained to think intuitively of these control circuits as two-level circuits, but a little reflection will show that they fall into this category. For example, if the relay and indicator-lamp circuits for a given piece of equipment are operated by a 24-volt supply with the positive terminal grounded, the two levels which can be found on any given line within the control system are 0 and -24 volts. Although the vast majority of the signals handled in current broadcast equipment are analog in nature (with significant waveforms that represent audio waves, picture information, error signals, or carrier frequencies), most pulse signals in the synchronizing category may properly be regarded as digital signals, since they generally move between two standardized levels.

The advanced applications of digital technology are based, in large measure, on the realization that vast amount of information can be processed by assigning coded meanings to the two available states in digital circuits. At first glance, it may seem that a wire that can assume only two different voltage states (which we may arbitrarily identify as HIGH and LOW) is severely limited as an information-transfer medium, but this is not necessarily the case. Even in relatively slow-acting control circuits, the coded meanings assigned to the HIGH-LOW combinations may be such useful concepts as OFF versus ON, ENABLE versus DISABLE, LOCAL versus REMOTE, ON-THE-AIR versus NOT-ON-THE-AIR, or DOORS OPEN versus DOORS CLOSED.

The entire field of electronic digital computation is based on the simple notion that two-state devices and bus wires may be used to represent the binary digits 0 and 1. If a designer needs to manipulate numbers larger than 1, he has a choice of serial or parallel approaches. For the serial approach, a single wire is used to transmit a "bit stream"; that is, the time domain is divided into definite intervals to permit the transmission of multi-digit binary numbers as sequences of high and low levels. For the parallel approach, a multiple set of bus wires

(and related circuit elements) is used, each bus wire representing one digit of the multi-digit number.

Digital computers and digital communication systems are by no means limited to the manipulation of binary numbers—letters of the alphabet, punctuation marks, and other "tools" of communication can be accommodated by simply assigning meanings to specific binary numbers (as is done in conventional teletypewriter codes). Even audio and video signals can be translated into digital form by sampling and quantizing processes.

A key advantage of digital technology, that often justifies the considerable effort and expense involved in converting analog information into coded digital form, is that signals are effectively re-generated at virtually every logic element. Although it is common practice to speak of digital or logic signals as having only two levels (nominally 0 volts and +5 volts for the majority of devices using integrated circuits), the fact is that there are very practical tolerance ranges for both the high and low levels, usually with a "forbidden zone" of intermediate levels where the logic state (HIGH or LOW) may be indeterminate. As long as the binary signal delivered to a logic element falls within the acceptable tolerance ranges, the circuit detects the intended level without ambiguity and delivers a standard HIGH or LOW at its output. Because of this re-establishment of standard levels at each stage, it is possible to do a great deal of information processing or transmission through long chains of circuit elements with no degradation of the signal-to-noise ratio.

The Truly Basic Logic Elements

Digital circuits are frequently called "logic circuits" (and the art of developing such circuits is commonly called *logic design*) because many of the pioneering workers in this field assigned the meanings TRUE and FALSE to the two possible states of binary devices or circuit elements and used them to implement desired functions through the application of "rules of logic". As an interesting historical footnote, the mathematical foundation for modern

digital technology was laid in a classic paper entitled "An Investigation of the Laws of Thought, on Which Are Founded the Mathematical Theories of Logic and Probabilities", published in 1854 by one George Boole, a professor of mathematics at Queen's College in Cork, Ireland. Boole's work evolved into the mathematical discipline we now know as Boolean Algebra. Although today's logic designers are seldom concerned with the truth or falsehood of philosophical arguments, the concepts TRUE and FALSE are sometimes used as alternatives to ZERO and ONE or HIGH and LOW, and it is common practice to refer to an orderly table expressing all possible combinations of input and output conditions for a logic circuit as a *truth table*.

Although many different types of devices and circuits can be used to implement digital circuits, there are, in a *functional* sense, only three truly basic logic elements. Each of these logic elements has a standardized symbol, and its operation can be specified by a *function table*, as shown in Fig. 1. Each of the three basic logic elements represents an implementation of one of the three *postulates* (or concepts established by definition) on which Boolean algebra is based. All digital circuits are built up from combinations of these three basic logic elements, although certain combinations are sufficiently common that they have symbols of their own.

The *inverter* is simply a logic element which converts a low level to a high level, or vice versa. Its symbol is the conventional triangle often used on block diagrams to represent an amplifier, supplemented by a small circle at either the input or the output. It is actually the small circle which denotes the process of inversion, and the draftsman who prepares a logic diagram has the option of placing it where he wishes (although an intelligent choice between the two symbols can often make a diagram easier to interpret). Implicit in the symbol are connections to ground and to a power supply bus (usually +5 for most integrated circuits), and the voltage levels at input and output are understood to be in reference to ground potential. The function table for the inverter identifies the output state for each of the possible input states (which are only two in number for the inverter, either low or high).

The Boolean algebra postulate implemented by the inverter is the process of *negation*. As George Boole might have stated it, "By definition, a statement that is not true is false; a statement that is not false is true." Several differ-

ent customs are used in writing Boolean algebra expressions to connote negation or inversion; we shall follow the most common practice among electrical engineers by using an overline to represent the NOT condition.

A two-input digital circuit whose output is high only if both inputs are high provides an implementation of the Boolean algebra postulate known as the AND function—also known as *logical multiplication*. To paraphrase George Boole, "The word AND is defined in such a way that when two statements are joined by AND the combined statement is true only if the two individual statements are true." On logic diagrams, the AND function is represented by a rounded-end block; inputs are shown at the flat end of the block, and the output is shown at the center of the rounded end. In logic equations, the AND function is usually represented by the same dot symbol used to represent arithmetic or algebraic multiplication. This is perhaps unfortunate, since Boolean algebra is an entirely different mathematical discipline, not to be confused with ordinary algebra, decimal arithmetic or binary arithmetic. The Boolean algebra expression used in Fig. 1, $Y = A \cdot B$, should never be read "Y equals A times B"; the proper reading is "Y equals A AND B." Logical multiplication can also be represented in Boolean algebra expressions by parentheses or by no mathematical symbol at all. For example, the function "Y equals A AND B" could also be written $Y = A(B)$ or $Y = AB$. In positive logic, an AND gate may be described either as one whose output is high only if all inputs are high, or as one whose output is low if there is a low on one or more inputs—these statements apply to AND gates with any number of inputs. (We shall comment on the differences between *positive logic* and *negative logic* at a later point in this paper.)

The Boolean algebra OR function can be implemented (in positive logic) by a circuit whose output is high whenever there is a high on one or more inputs. Stated the other way around, an OR gate is a circuit whose output is low only when there are lows on all inputs. George Boole might have expressed the OR function in this manner: "The word OR is defined in such a way that when two statements are joined by OR the combined statement is true if either or both of the individual statements are true; the combined statement is false only if both individual statements are false." Under Boole's postulate, the word OR takes on an *inclusive* mean-

ing; this is worth pointing out, because in ordinary English speech the word usually implies an *exclusive* meaning. According to Boole's "ground rules", you would be justified in answering "yes" when your wife asks you, "Do you want your eggs fried or scrambled this morning?" If you value your marriage, however, you will recognize that your wife is using the word *or* with the implicit assumption that you will choose one or the other but not both.

The logic-diagram symbol for the OR function is a shield-shaped block as shown in Fig. 1. The OR function is also known as *logical addition*, and is often represented in Boolean algebra equations by the same + sign used to represent addition or positive quantities in decimal arithmetic, binary arithmetic, or ordinary algebra. This is also unfortunate, because the meaning of the symbol in Boolean algebra is entirely different from its meaning in the other mathematical disciplines. In Boolean algebra, the expression $Y = A + B$ should be read as "Y equals A OR B", never as "Y equals A plus B."

The Familiar Relay as a Logic Element

An important aspect of my operating philosophy as a training manager is that people can most rapidly accept a new technical concept if they can *visualize* it and *relate* it to something in their past experience. In this spirit, I suggest that the broadcast engineer or technician who has not yet acquired enough knowledge of digital technology to feel comfortable about his ability to read logic diagrams can benefit by a brief study of the functional relationships between the standard logic symbols and familiar relay circuits. Relays have been around for a great many years, and their operation is easy to visualize; relays can be used, therefore, to illustrate the basic simplicity of the concepts involved in even the most complex of digital circuits.

As shown in Fig. 2, the two-input AND gate is functionally equivalent to a pair of relays with their contacts connected in series. For consistency with the integrated-circuit logic elements we shall discuss later, we shall assume the use of relays capable of working with a 5-volt supply, so that our logic HIGH level will be +5 volts and our logic LOW will be at ground potential. One can see, almost at a glance, that the output terminal (labeled Y in the diagram) will be in the HIGH state only if HIGH levels are applied to both the A and B inputs. Because the Y terminal would normally be connected either to the input of some similar gate circuit

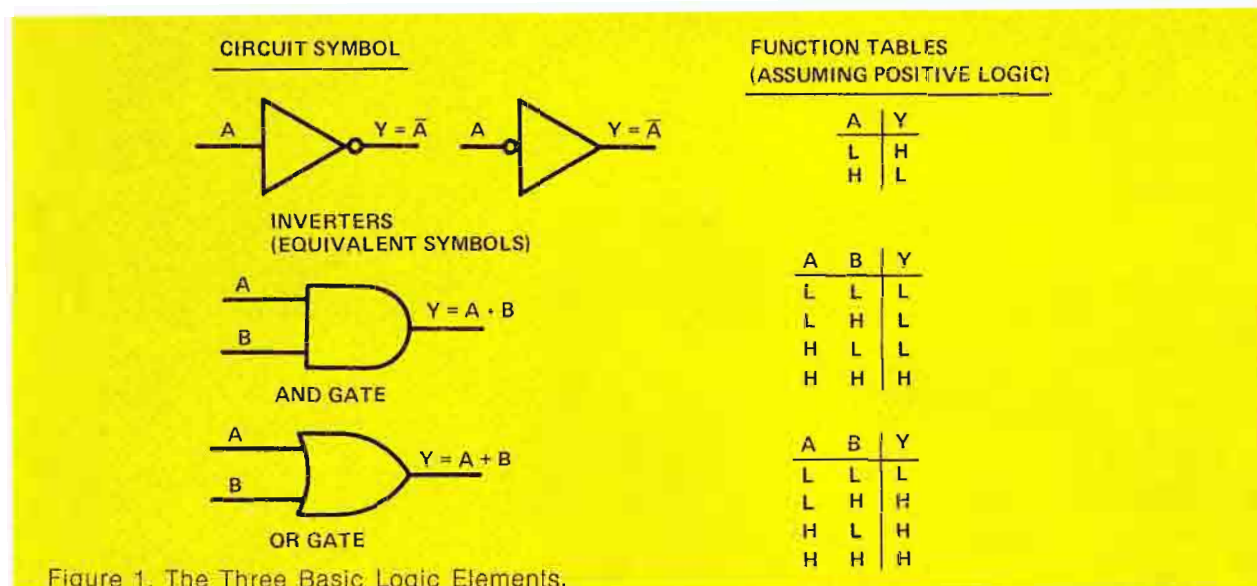

Figure 1. The Three Basic Logic Elements.

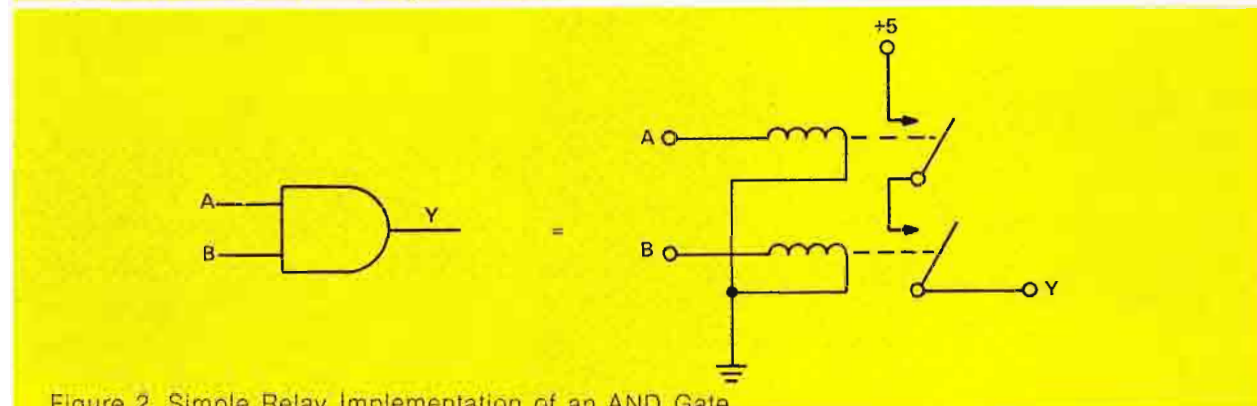

Figure 2. Simple Relay Implementation of an AND Gate.

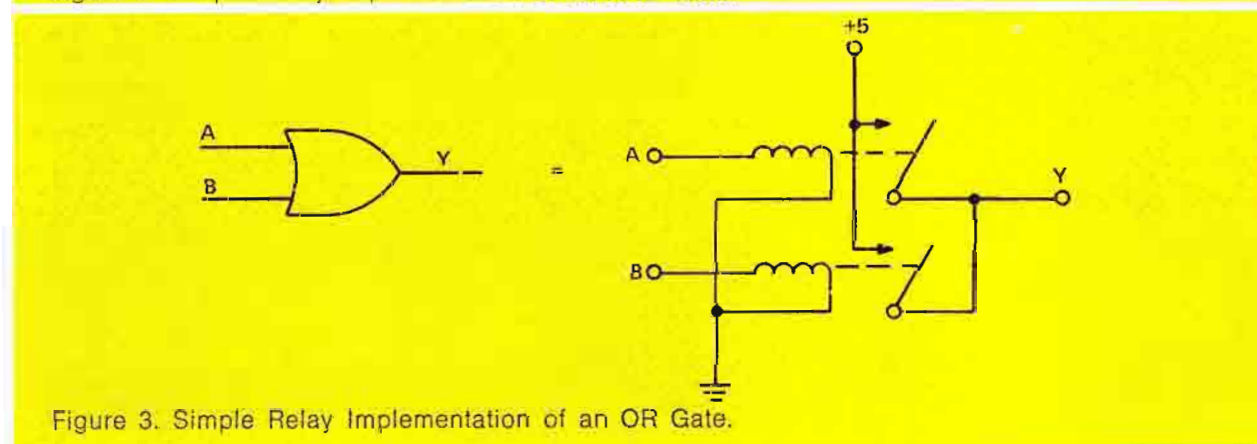

Figure 3. Simple Relay Implementation of an OR Gate.

or to some type of OFF-ON load (such as a relay, a solenoid, or a lamp), the potential at Y would be at ground if there is a LOW state at either Input A or Input B. An AND gate with more than two inputs could be implemented by using more than two relays, placing all contact sets in series.

Although the use of relay circuits as an aid in visualizing the behavior of logic elements can be very helpful, a few words of caution are needed. The actual switching characteristics of simple relays are quite different from the various solid-state circuits used in actual practice—integrated-circuit logic elements do not have the inductive “kick” effects associated with relay coils, switching times are usually much shorter than with moving-armature relays, there are no problems with contact bounce, and the “off” or LOW state of an IC gate may not necessarily be an open circuit as implied in Figure 2. On the other hand, the simple relay circuit of Figure 2 is quite realistic in the sense that it involves connections to +5 and to ground (which are not shown but which are, nevertheless, implicit in the standard logic symbol). The simple relay circuit also re-generates the output signal, in the sense that the output terminal is driven directly from the power

supply, not from either of the input buses (which may have degraded levels because of transmission line losses or heavy loading).

As shown in Fig. 3, the two-input OR gate is functionally equivalent to a pair of relays with their contacts connected in parallel. Anyone at all familiar with relays can see that the Y output terminal of this circuit will be at the logic HIGH level (+5 volts) if there is a HIGH level on either Input A or Input B or both. An OR gate with three or more inputs could be implemented by adding more relays with their contact sets in parallel.

The relay equivalent of a logic inverter can be constructed with either normally-closed or normally-open contacts, as shown in Fig. 4. In either case, the application of a logic HIGH to the input terminal (A) will cause the output terminal (Y) to go from the HIGH to the LOW state. In the version using normally-open contacts, the resistor R must have a value small enough to pass the current required to operate the relay or other circuit element connected to the output terminal when the terminal is in the HIGH state, but large enough to limit the current drawn from the power sup-

ply to a reasonable value when the output terminal is grounded. Although this type of circuit is not particularly efficient, it is a fairly close analog of practical integrated-circuit gates using saturated transistors as switching elements. Incidentally, the word *gate* is frequently used in a generic sense to designate all logic elements, including simple inverters.

Typical Broadcast Applications of Basic Gate Circuits

I am confident that most readers have experienced no difficulty in visualizing the operation of basic logic gates when implemented with relays, and I suspect that many have already recognized these circuits as familiar “friends”, frequently encountered in the control aspects of broadcast equipment.

In general, the AND function is used when two or more conditions must be satisfied simultaneously before some control action is undertaken. For example, Figure 5 shows a typical application for a five-input AND gate in the control of a broadcast transmitter. In starting up a transmitter, one does not necessarily want plate power to be applied at the same instant an operator throws the plate switch to the ON position. Each of the inputs to an AND gate can function as an ENABLE-DISABLE control point, so the plate power will not actually be applied until all of the pre-conditions are satisfied.

The OR function is used whenever it is intended that a control action be initiated by any one (or more) of several possible inputs. For example, the control of a master warning bus in a transmitter might well be handled by an OR gate in the manner illustrated by Figure 6.

In broadcast studio equipment, machine-control circuits provide numerous examples of both AND and OR functions. For instance, Figure 7 (A) shows how an AND gate might be used to enable or inhibit the use of a machine START button on a remote control panel, and Figure 7 (B) shows how a machine (such as a film projector or a tape recorder) might be controlled from either of two locations through an OR gate.

A frequently-needed *selector* circuit based on logic elements is shown in Figure 8. In this case, it is assumed that it is desired that a machine be started from either of two locations (LOCAL and REMOTE), but it is also desired that the control function be clearly delegated to one location or the other for any given operating period. This can be accomplished by using

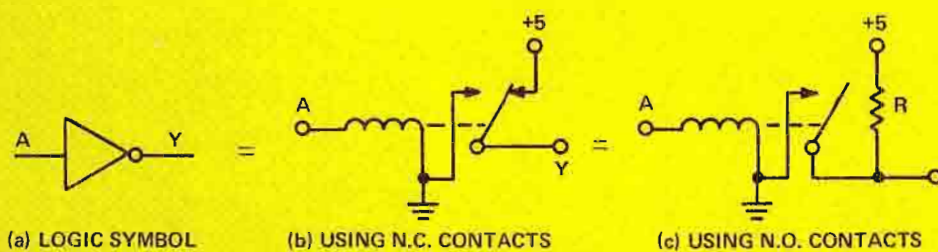

Figure 4. Simple Relay Implementations for an Inverter.

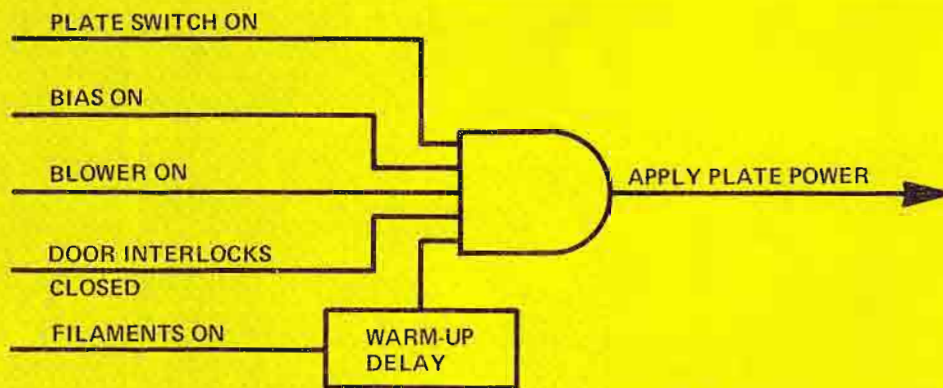

Figure 5. Typical Broadcast Transmitter Application of an "AND" Function.

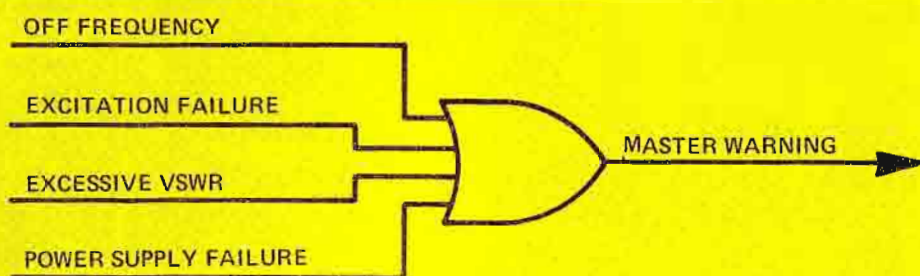

Figure 6. Typical Broadcast Transmitter Application of an "OR" Function.

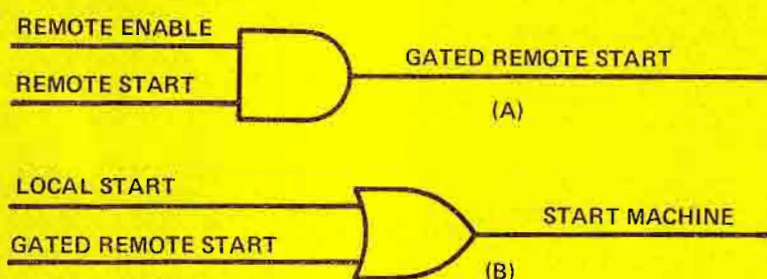

Figure 7. Typical Broadcast Machine-Control Applications of Logic Elements.

a pair of AND gates and a single delegation-control bus linked to the AND gates through an inverter. If the ENABLE REMOTE control line is HIGH, the upper AND gate is enabled so that the appearance of a logic HIGH on the REMOTE START bus will lead to a START MACHINE command; the lower AND gate would be inhibited under these conditions, however, since the logic LOW at the output of the inverter (point X in the diagram) would prevent the output of the lower gate from going HIGH even if the LOCAL START line should go HIGH. If the ENABLE REMOTE line goes LOW, however, the upper gate would become inhibited but point X would go HIGH, thus enabling the lower gate and allowing the LOCAL START bus to assume control of the START MACHINE bus.

Still another example of a machine-control function implemented with logic gates is shown in Figure 9. In a quadruplex video tape machine, it is necessary that the vacuum guide be pulled in to cause the tape to contact the

rotating headwheel in either the RECORD or PLAY operating modes, but only after a sensor circuit in the headwheel servo indicates that the headwheel has achieved a velocity lock. It happens that in many machines the condition of VELOCITY LOCK is actually indicated by the appearance of a logic LOW on a control bus that would normally be referred to as a "low-active velocity lock bus". (Literally it is a NOT VELOCITY LOCK bus, meaning that the bus is in the high state when the machine is not in velocity lock.) An inverter may be used to convert the available logic signal into the level needed for proper control of the final AND gate which drives the ACTUATE VACUUM GUIDE PULL-IN bus.

These few examples should suffice to establish the point that the basic logic gating circuits are really very simple and not at all new to the broadcaster. The present excitement about digital technology derives chiefly from the fact that it is now possible to purchase and use these logic circuits as pre-construct-

ed functional "blocks" in extremely compact, economical packages. While it is possible to build up these circuits from old-fashioned relays and other discrete components, it is no longer necessary to do so. The functional blocks now available are so convenient, cheap, and miniaturized that it is practical to develop control circuits with far greater sophistication than would have been reasonable before the introduction of integrated circuits.

Composite Gates—NAND and NOR

Because of the intrinsic polarity inversion provided by transistors in the popular common-emitter configuration, the majority of integrated-circuit gates based on transistors introduce an inversion as well as an AND or OR gating function. The combination of an AND gate and an inverter is sufficiently commonplace that it is assigned a special symbol, as shown in Fig. 10; the composite circuit is known as a NAND gate, the word NAND being a contraction of NOT AND. As illustrated by the function table of Fig. 10(b), the output of a NAND gate (in positive logic) is low only when all inputs are high. Conversely, the output is high if there is a low on one or more inputs.

A simple relay implementation for the NAND gate is shown in Fig. 10 (c).

Another composite gate that is assigned a special symbol is the NOT OR or NOR gate shown in Fig. 11. The output from this type of gate is high only when all inputs are low; the appearance of a high on one or more of the inputs will cause the output to go low. Fig. 11(c) shows how such a gate can be implemented with simple relays.

Still another composite gate that has a number of applications is the EXCLUSIVE OR gate shown in Fig. 12. This gate differs from the basic OR gate in that the output does not go high when highs are present on both inputs. The most common Boolean algebra symbol for EXCLUSIVE OR is a plus sign with a circle drawn around it, and the logic-diagram symbol is similar to that of the basic OR gate except that a double line is drawn for the input side of the gate. As shown by both the Boolean algebra equation and the detailed logic diagram in Fig. 12, "A exclusive or B" is equivalent to "A or B and not A and B".

If the composite logic diagram shown at the lower right in Fig. 12 is constructed with relay logic patterned after the basic relay circuits previously presented, the result might appear as shown in Fig. 13. Relays m and n form an OR gate, o and p form a NAND gate,

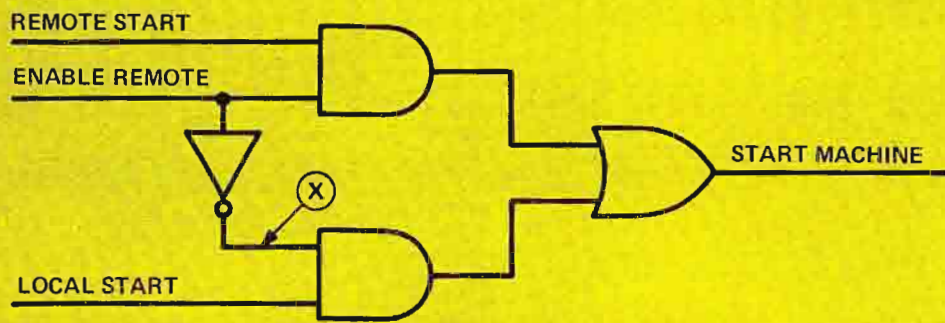

Figure 8. Typical Machine-Control Selector Circuit Implemented with Logic Elements.

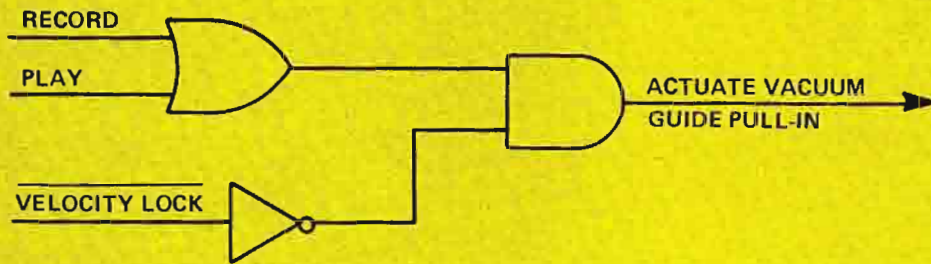

Figure 9. Typical Application of Logic Elements in a Video Tape Machine.

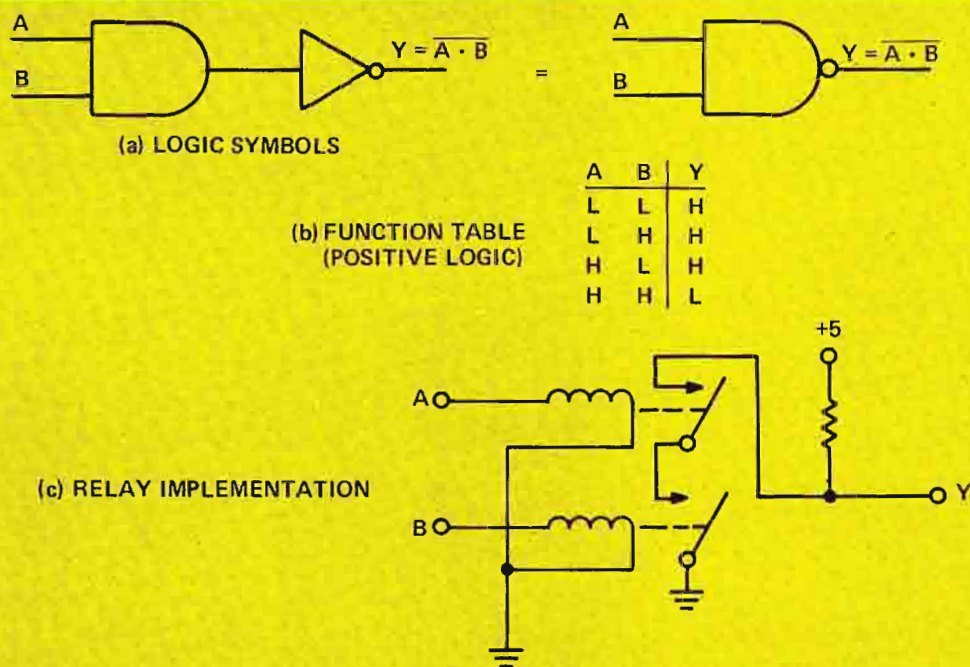

Figure 10. Two-Input NAND (NOT AND) Gate.

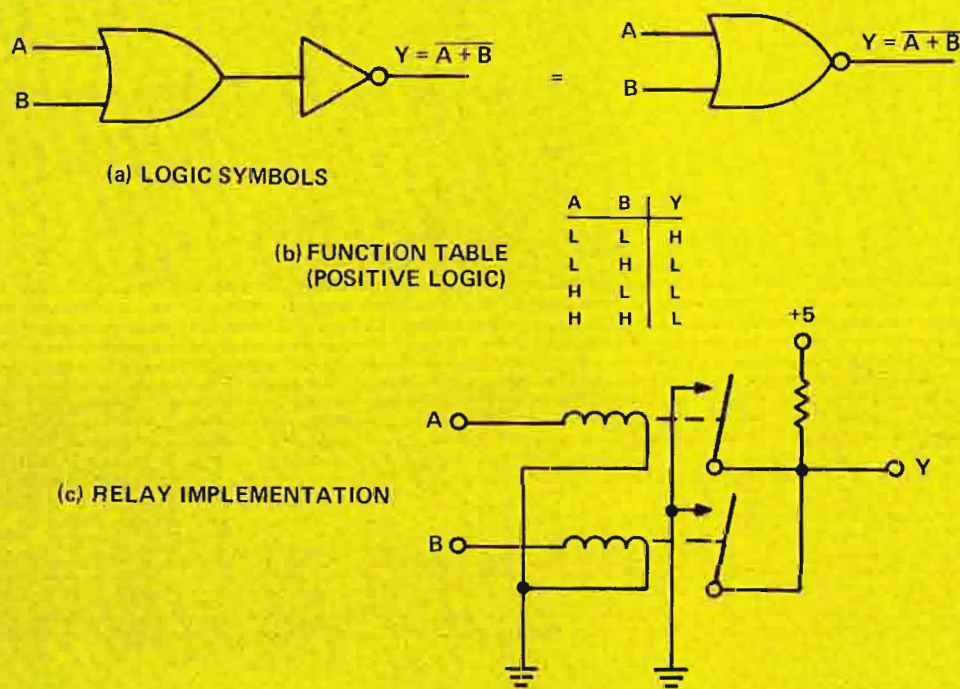

Figure 11. Two-Input NOR (NOT OR) Gates.

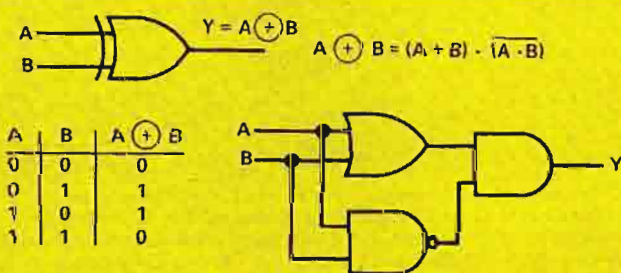

Figure 12. Exclusive OR Gate.

and q and r form the output AND gate. Resistor R is assumed to have a sufficiently low value that Relay r will be kept energized unless the closing of both o and p grounds the lower end of R. A brief study of this diagram will show that the output terminal (Y) will be high if either A or B is high but not if both are high.

One important application of the EXCLUSIVE OR gate is encountered in everyday experience. If the two possible positions of the toggles frequently used for wall-mounted light-control switches are identified as HIGH and LOW, the so-called "two-way light control circuit" commonly used to permit control of a hallway light from either an upstairs or downstairs location may be recognized as an EXCLUSIVE OR circuit. That is, the light will be ON if one toggle or the other is in the HIGH position, but the light will be OFF if both toggles are either HIGH or LOW. Recognition of the EXCLUSIVE OR character of the familiar two-way lighting circuit suggests that the relay circuit of Fig. 12 may be an unnecessarily complex approach to the implementation of an EXCLUSIVE OR function. A much simpler circuit that has the same functional behavior is shown in Fig. 14. A comparison of Fig. 14 with Fig. 13 illustrates the point that there are often alternative ways of constructing composite logic circuits, some simpler than others. The key to the simplicity of Fig. 14 is, of course, the use of SPDT contacts on the relays—most solid-state devices do not have this same capability unless multiple transistors are used.

A variation of the EXCLUSIVE OR gate that has important practical applications is the EXCLUSIVE NOR gate shown in Fig. 15. The output of this circuit is high whenever the two inputs match each other, whether both are LOW or both are HIGH. This characteristic makes the EXCLUSIVE NOR gate very useful as a comparator for binary numbers; for multi-digit numbers, a separate comparator is used for each pair of digits. When two numbers match each other, digit for digit, the outputs of all comparators will go high simultaneously. The relay version of an EXCLUSIVE OR gate shown in Fig. 14 could be converted to an EXCLUSIVE NOR gate by simply omitting the cross-over in the connections between the upper and lower sets of contacts.

Prototype DTL Circuits

Because it is impossible to visualize relay circuits working at microsecond or nanosecond speeds, we should intro-

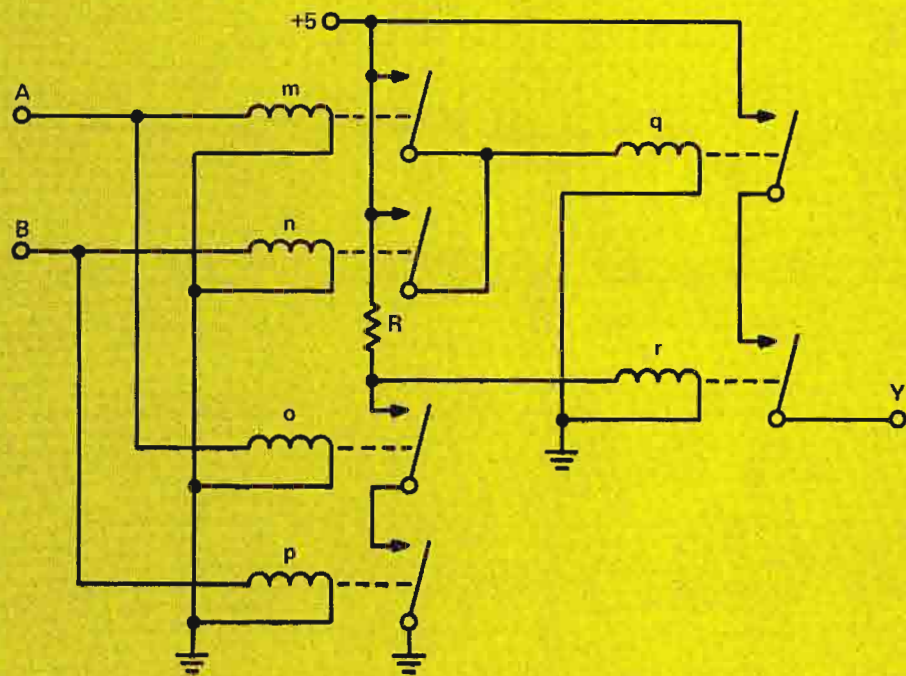

Figure 13. Possible Relay Implementation of Exclusive OR Function.

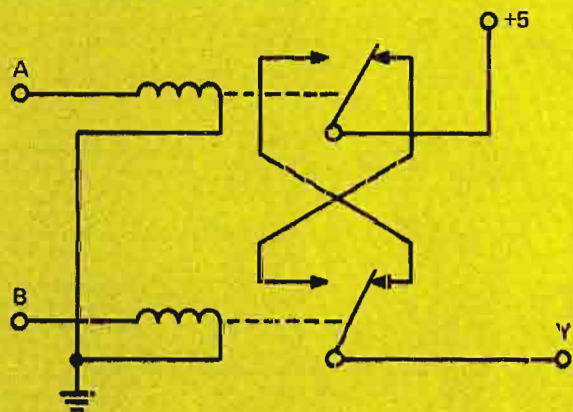
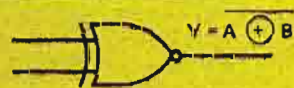

Figure 14. Two-Relay Version of Exclusive OR Circuit.



TRUTH TABLE			FUNCTION TABLE (POSITIVE LOGIC)		
A	B	A ⊕ B	A	B	Y
0	0	1	L	L	H
0	1	0	L	H	L
1	0	0	H	L	L
1	1	1	H	H	H

Figure 15. Exclusive NOR Gate.

duce at least simple versions of electronic circuits that can be used to implement the basic logic functions before we proceed to discuss pulse applications of logic elements. In Part II of this series of articles, we shall discuss the major properties of several "families" of logic devices, but for the present we shall limit our attention to prototype versions of "Diode-Transistor Logic" (DTL) circuits. (These simple prototype circuits work properly and illustrate basic operating principles, but they lack certain protection and performance-improving features found in most commercial DTL integrated circuits.)

A brief review of some of the properties of silicon p-n junctions is appropriate before we look at specific DTL circuits. The current-versus-voltage characteristic for a silicon junction is shown in comparison with a simple linear resistor in Fig. 16. When the silicon diode is reverse-biased, the current flow is negligibly small (for present discussion

purposes), as indicated by the heavy line which extends along the $-E$ axis. Even when a forward bias is applied, the diode does not begin to conduct significantly until the forward voltage is approximately 0.35 volts, corresponding to point (a) on the diode characteristic. At this point, the forward conductance is still quite low (or the resistance is very high), as indicated by the very low slope of the curve just to the right of point (a). As the forward bias is increased, however, the conductance increases quite rapidly (or the resistance decreases) until the slope reaches a maximum value that is a function primarily of the cross-section area of the junction. For signal-handling diodes (or the forward-biased emitter junctions of transistors), this resistance is typically in the range of 10 to 100 ohms. The forward-biased junction differs from a simple resistor of the same ohmic value, however, in that its characteristic is displaced from the origin of the E-I plot by an *offset*

voltage of about 0.65 volts. This voltage is nominally independent of the size of the diode (or transistor emitter junction), since it is determined by the atomic characteristics of the silicon material. In many textbook discussions, the offset voltage for silicon is customarily "rounded off" to either 0.6 volts or 0.7 volts. We shall use the 0.7-volt figure for this discussion.

A prototype inverter circuit is shown in Fig. 17. The steady-state performance characteristics of this circuit are quite easy to analyze if one recognizes that the circuit is intended to respond to only two basic levels at its input—either 0 or nominally +5 volts. The allowable input conditions may be simulated, therefore, by the SPDT switch shown at the left of Fig. 17. If terminal A is grounded, the input diode is forward-biased by the flow of current from the +5-volt supply through the 5K resistor, and the voltage at point (a) is pulled down to 0.7 volts. The two diodes in series with the base lead for the transistor have electrical properties virtually identical to those of the base-to-emitter junction within the transistor (since all p-n junctions in the integrated circuit are fabricated at the same time within mils of each other). Hence the 0.7 volts at point (a) will be divided evenly across three junctions, providing a potential of 0.47 volts at point (b) and 0.23 volts at point (c). The +0.23-volt bias at point (c) is below the value designated (a) in Figure 16, and is thus too small to turn on the transistor. Since the transistor is cut off, there is no voltage drop across its 2K load resistor, and the output terminal (Y) is at the logic HIGH level of +5 volts. We have shown, therefore, that a logic LOW at the input terminal of the inverter leads to a logic HIGH at the output terminal.

If the input terminal of the inverter is switched to a logic HIGH (nominally +5 volts), the input diode will be cut off, since there is no source of forward bias for this diode. The transistor will then be turned "on" by the flow of bias current through the 5K resistor, the two series diodes and the base-to-emitter transistor junction. The voltages at points (c), (b) and (a) will be +0.7, +1.4, and +2.1, respectively. The transistor will be driven into *saturation*; the flow of current through the collector load resistor will pull the voltage at the output terminal (Y) down to the logic LOW level of nominally ground potential (actually about 0.2 volts positive). When a bipolar transistor is saturated, the collector voltage actually falls below the potential of the base and the collector junction, as well as

the emitter junction, becomes forward biased. The input diode is clearly cut off, since the anode connected to point (a) is held at 2.1 volts while the cathode may be as high as +5 volts.

The prototype DTL inverter may be converted to a NAND gate by the simple connection of additional input diodes as shown in Fig. 18. Point (a) in the circuit may now be pulled down to 0.7 volts (thereby cutting off the transistor and enabling the output to go HIGH) by the application of a

LOW on any input. The only circumstances under which the output will be LOW is when there are HIGHS on all inputs. This is the proper behavior of a positive-logic NAND gate.

A prototype DTL NOR gate can be constructed by combining two basic inverter circuits in the manner illustrated by Fig. 19. In this case, a logic HIGH at either A or B (or both) will cause the output terminal (Y) to go LOW, since one transistor or the other will conduct and provide an effective

connection to ground. The only circumstance under which the output terminal will remain HIGH is when both input terminals are LOW. Rather obviously, more inputs could be provided by connecting still more inverter circuits in parallel.

The prototype DTL circuits presented here are capable of switching from HIGH to LOW states at the output terminals in 25 nanoseconds or less; switching times may be a little greater in going from LOW to HIGH states, however, because of the time required to "sweep out" minority carriers from saturated junctions when it is desired to turn them off. In a great many broadcast applications, particularly in the machine-control area, switching times are not critical because the devices to be controlled usually have operating cycles of the order of milliseconds or longer.

Levels of Integration

The most popular physical packages for the integrated-circuit logic elements currently used in broadcast equipment are the 14-pin and 16-pin Dual In-Line Packages, commonly known as DIP's. The so-called *level of integration* is determined by the number of logic elements constructed on a single silicon "chip" and mounted in a single package. In the catalog literature of most manufacturers in this field, the term *small-scale integration* (SSI) is used to refer to arrays of no more than 12 logic elements per package, *medium-scale integration* (MSI) refers to arrays or functional groupings of from 13 to 99 gates, and *large-scale integration* refers to complex circuits with the equivalent of more than 100 logic elements. LSI packages frequently require more than 16 pins to handle the necessary interconnections. For present discussion purposes, we shall limit our attention to small-scale integration.

Typical approaches to the utilization of 14-pin SSI packages are shown in Figure 20. Two of the four pins are required for connections to ground and the +5-volt power supply; these connections are common to all elements mounted on the chip. The remaining 12 terminals can then be used to provide access to the input and output terminals for 6 inverters, 4 two-input gates, 3 three-input gates, or a pair of 4-input gates. The *expander terminals* shown for the dual 4-input NAND gate package provide access to the internal circuit point identified in Fig. 18 where additional external diodes may be attached to provide more inputs; this feature is useful in equipment where

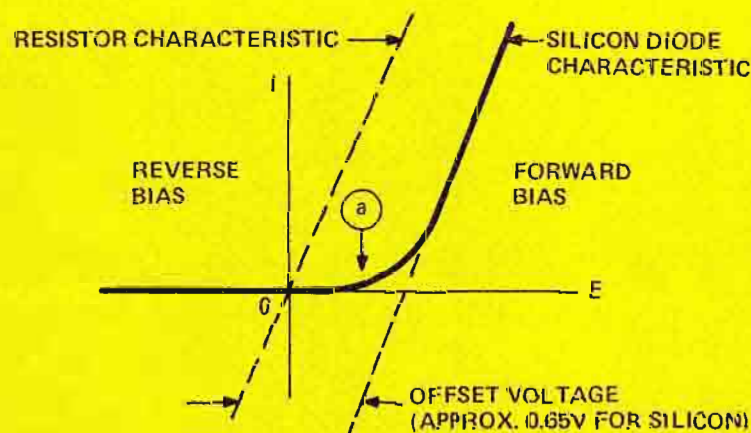

Figure 16. Silicon Diode Characteristic.

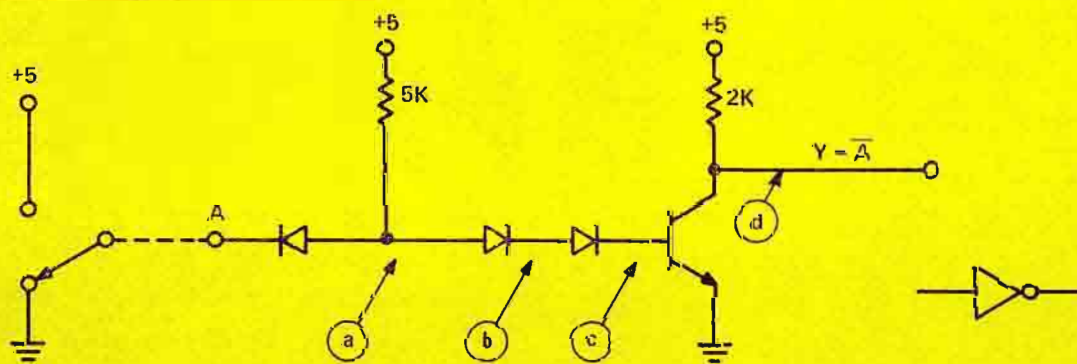

Figure 17. Prototype DTL Inverter.

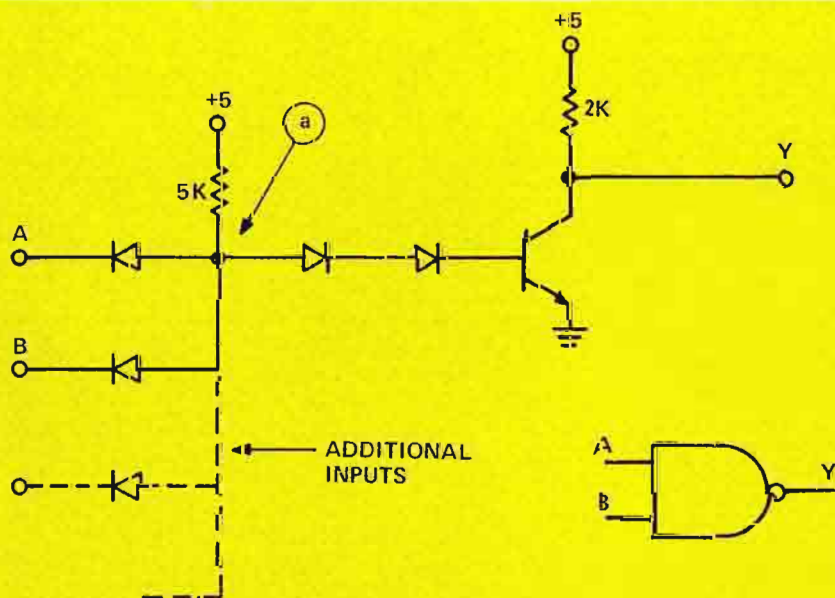

Figure 18. Prototype DTL NAND Gate.

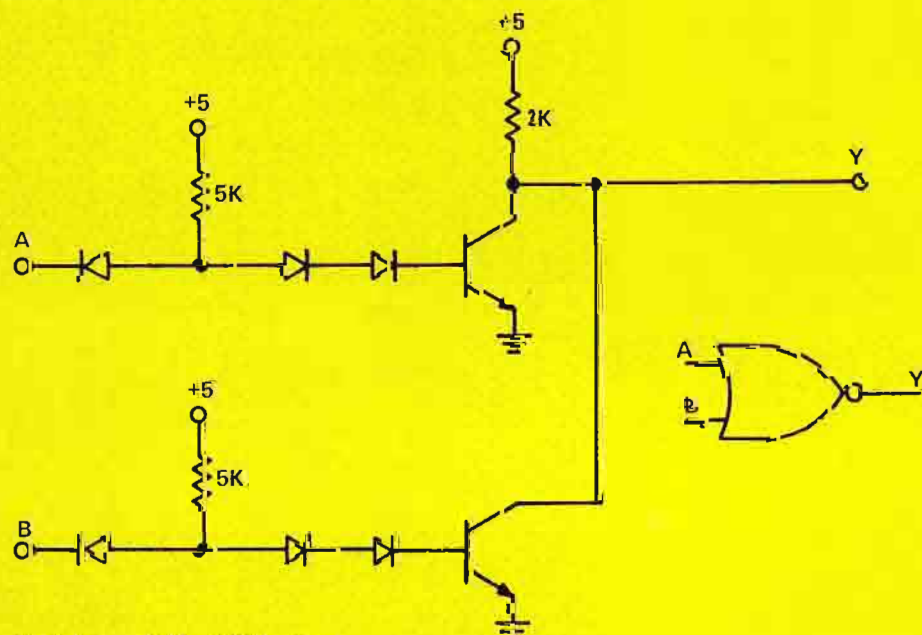

Figure 19. Prototype DTL NOR Gate.

TYPICAL COMBINATIONS OF GATES IN IC PACKAGES

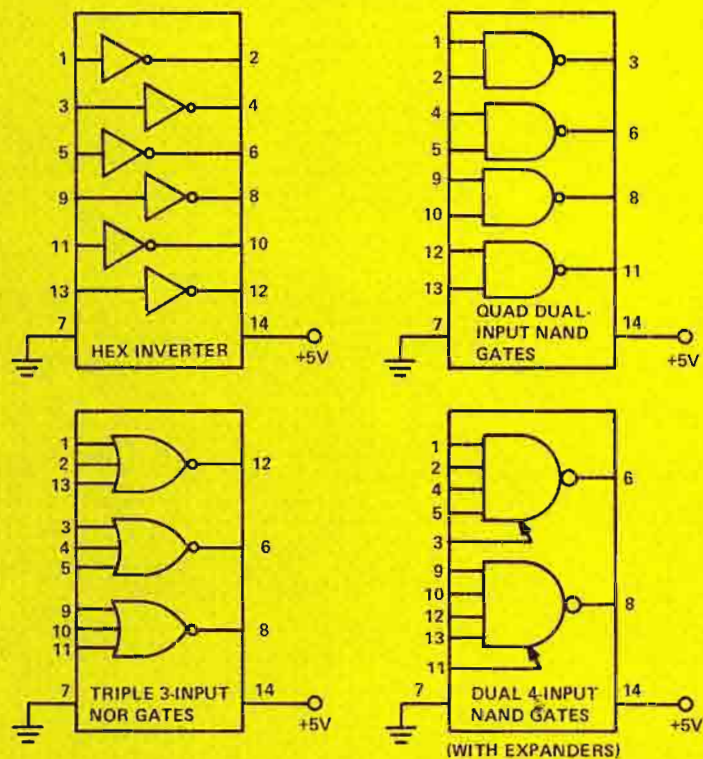

Figure 20. Typical Combinations of Gates in IC Packages.

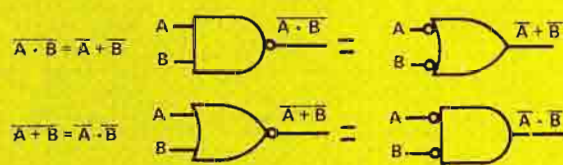

Figure 21. DeMorgan's Theorems.

there is only occasional need for a large number of inputs.

One consequence of the conventional packaging arrangement for SSI logic elements is that there is often very little correlation between the logic *functions* to be performed and the IC *packages*. For example, the control of a given machine function may require the use of one NAND gate, one NOR gate and two inverters. These elements will probably be found in three different packages, and those same packages will also house the logic elements used for a variety of other machine functions. The packages simply provide useful clusters of logic elements which may be interconnected externally to perform the required control functions. In medium-scale and large-scale integration, one is more likely to find that the logic elements are internally arranged to perform some specific overall function.

DeMorgan's Theorems

We noted in Section C of this article that each of the truly basic logic elements serves to implement one of the *postulates* of the mathematical discipline known as Boolean algebra. This branch of mathematics also includes a set of *theorems*, which are propositions or formulas which can be proved by logical arguments derived from the postulates or previously-proved theorems. Boolean algebra is a tool of considerable value to the logic *designer*, but it is not necessary for the engineer or technician concerned primarily with analyzing and understanding pre-exist-

ing designs to spend a lot of time learning the details of the various theorems. (The chief value of Boolean algebra is in the development and manipulation of mathematical models of logic circuits before they are created in hardware—intelligent use of mathematics, plus the graphical design technique known as Karnaugh mapping, enables a designer to find the *simplest* logic circuit to accomplish a desired task without resorting to cut-and-try methods). Knowledge of one particular pair of Boolean-algebra theorems, however, can help the user of modern digital equipment understand many aspects of the logic diagrams that might otherwise be quite puzzling. The theorems in question, frequently presented as numbers 19 and 20 in textbook listings of Boolean algebra theorems, are known as DeMorgan's Theorems or DeMorgan's Laws, in honor of their discoverer, another English mathematician who was a contemporary of George Boole. These theorems are presented both as Boolean algebra equations and as logic symbols in Fig. 21.

In mathematical language, DeMorgan's first theorem states that "Not (A and B) is equivalent to Not A or Not B". Expressed in logic symbols, this theorem tells us that a NAND gate is fully equivalent to a *low-active* OR gate, or an OR gate preceded by inverters on the two inputs (as symbolized by the small circles at the inputs to the OR gate in the upper right-hand corner of Fig. 21). This immediately suggests that a NAND gate can be drawn in

either of two ways on a logic diagram, and selection of the more appropriate form of the symbol can be extremely helpful to the engineer or technician who is trying to interpret an unfamiliar diagram.

The second of DeMorgan's theorems, also shown in Fig. 21, states that "Not (A or B) is equivalent to Not A and Not B." Expressed in logic symbols, this theorem asserts that a NOR gate is equivalent to a *low-active* AND gate, or an AND gate preceded by inverters on each of its inputs. As in the case of the NAND gate, the draftsman who prepares logic symbol for a NOR gate has a choice of two forms for the symbol, and the proper choice can make the task of interpreting the diagram much easier.

DeMorgan's theorems can be proved by a variety of approaches, but one of the simplest and most convincing is by simple examination and interpretation of the function tables for NAND and NOR gates. Let us examine the function table for a positive-logic NAND gate (first presented in Fig. 10).

Line No.	Inputs		Output
	A	B	$Y = A \cdot B$
1	L	L	H
2	L	H	H
3	H	L	H
4	H	H	L

Line 4 of this table is the one which most directly expresses the useful functions of a NAND gate. When you see a NAND gate on a logic diagram, you can usually determine its function most readily (assuming that the draftsman knew what he was doing) by saying to yourself, "Here is a gate whose output will go low only when highs are present on all inputs." In other applications of the same circuit element, however, Lines 1, 2 and 3 may be of primary interest. In this case, the draftsman should have chosen the low-active OR gate symbol, and you can interpret the diagram readily by saying to yourself, "Here is a gate whose output will be high as long as there is a low on at least one of the inputs." The two ways of interpreting the logic function are fully compatible. The output of a NAND gate will go high if there is a low anywhere in the array of inputs, and the output of a low-active OR gate (which is just another way of looking at a NAND gate) will go low if there are highs on all inputs.

In like manner, we may examine the function table for a NOR gate (previously presented in Fig. 11), and note

that there are two points of view that may be useful in its interpretation (and in selection of the appropriate symbol).

Line No.	Inputs		Output
	A	B	$Y = A + B$
1	L	L	H
2	L	H	L
3	H	L	L
4	H	H	L

In applications where primary interest is in Lines 2, 3 and 4, the appropriate symbol is the basic NOR gate symbol, and you can best interpret the logic diagram by saying to yourself, "Here is a gate whose output will be low if there is a high on one or more of the inputs." In a different application where the primary interest is centered on Line 1 of the function table, however, the better symbol is the low-active AND gate and the proper frame of mind when reading the diagram is contained in the statement, "Here is a gate whose output is high only when there are lows on all inputs." Note that the two interpretations of the NOR gate suggested here are mutually consistent.

Logic with all NAND or All NOR Gates

One practical consequence of DeMorgan's Theorems is that it is possible to construct any of the basic logic circuits (inverters, AND gates and OR gates) and also the most common composite gates (NAND and NOR) from basic "building blocks" consisting of either all NAND gates or all NOR gates. This is often helpful in minimizing the number of different types of IC packages that must be purchased to build or maintain digital equipment. As shown in Figures 22 and 23, either a NAND gate or a NOR gate may be converted to an inverter by simply tying its inputs together. Groups of NAND gates (some with inputs shorted) may be combined as shown in Fig. 22 to synthesize AND, OR and NOR functions. Groups of NOR gates (again some with inputs shorted) can be combined as shown in Fig. 23 to synthesize OR, AND and NAND functions.

A Typical Pulse Application of Logic Elements in Broadcast Equipment

A design problem that frequently occurs in broadcast equipment is that of selecting either of two possible pulse or timing signals. Let us cite four specific examples.

(1) The reference generator in a video tape machine is sometimes controlled by local station sync directly from the sync generator, but at other times it must be controlled by sync stripped from an incoming video signal.

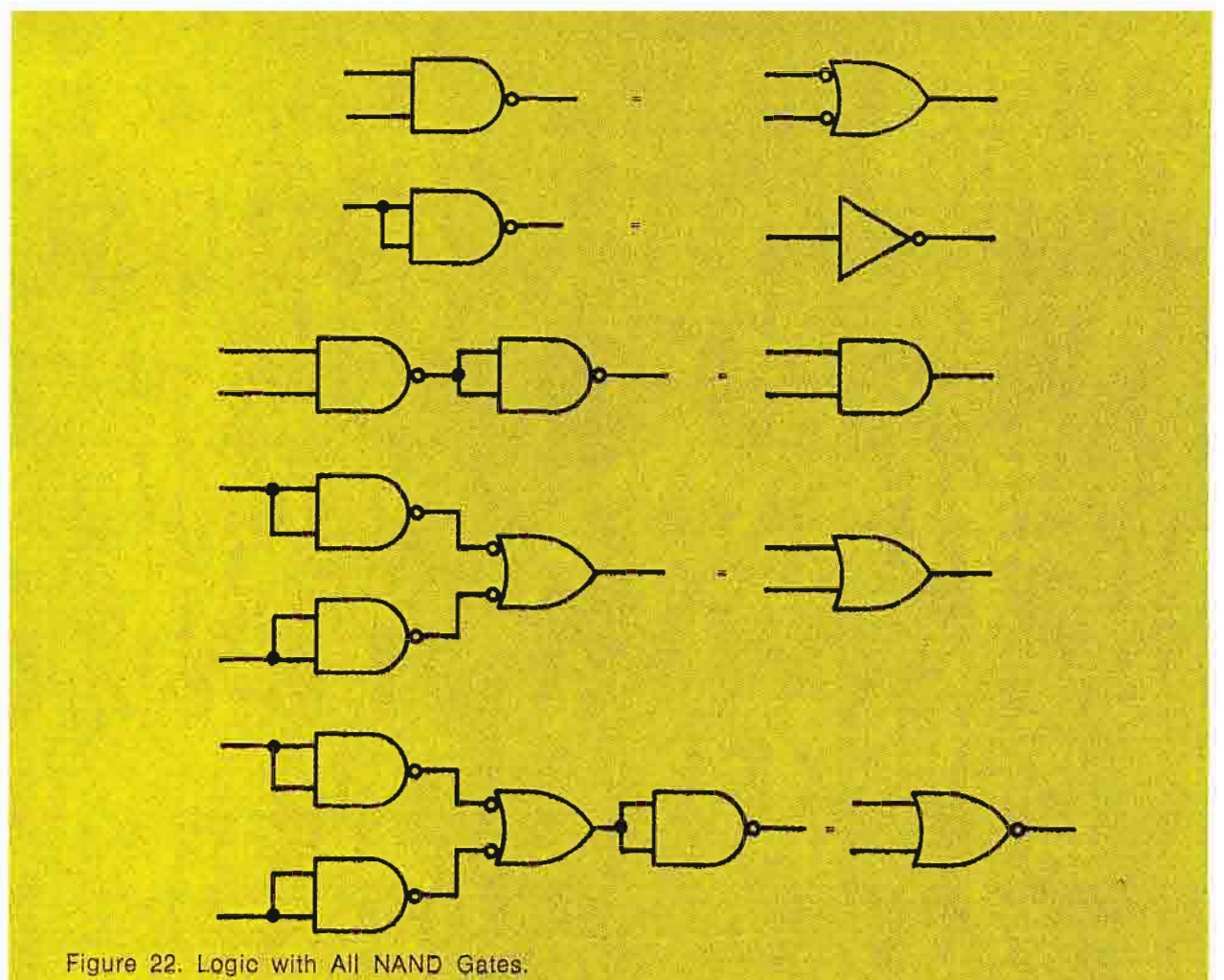

Figure 22. Logic with All NAND Gates.

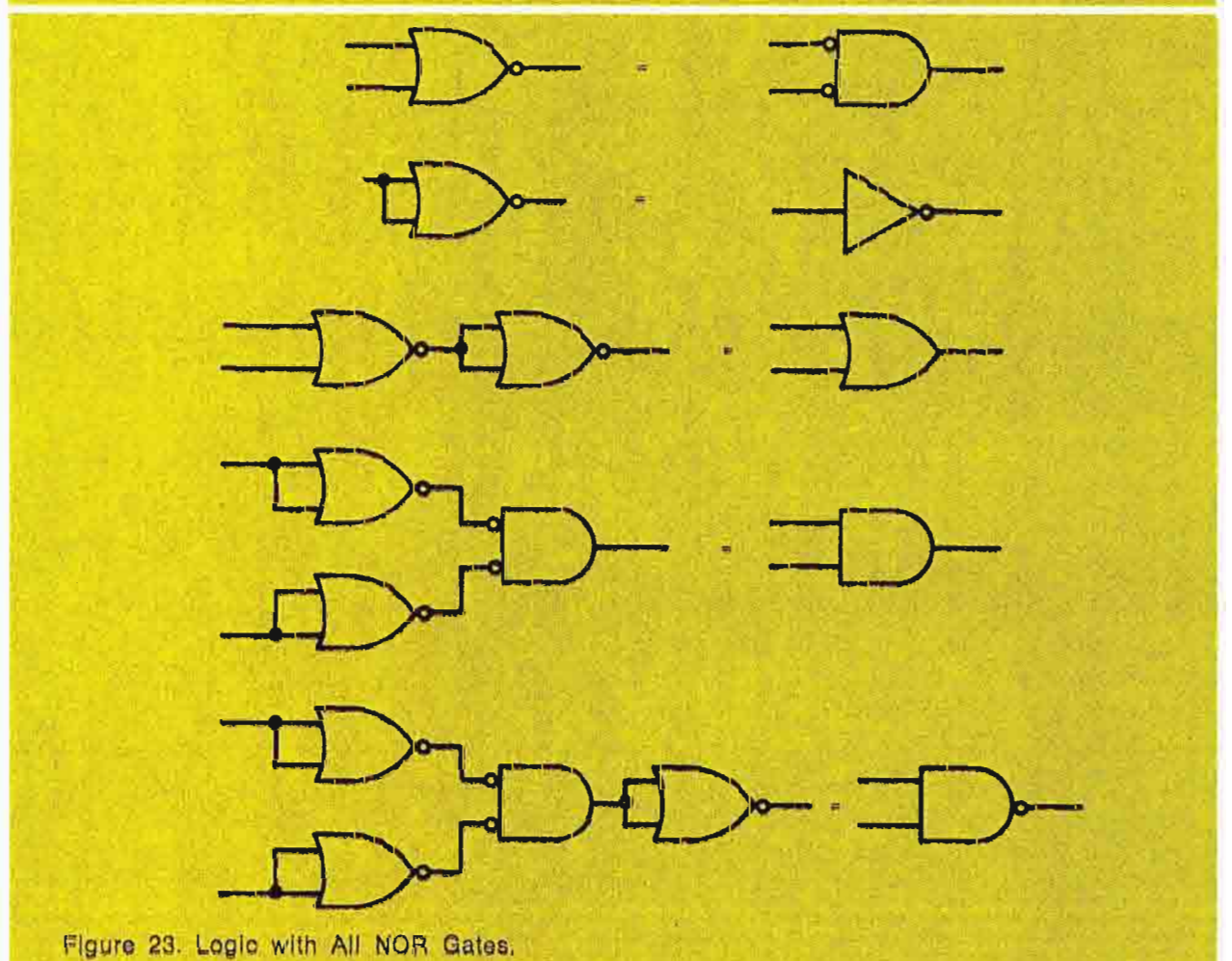

Figure 23. Logic with All NOR Gates.

- (2) The time-base generator of a waveform monitor is sometimes controlled by horizontal-rate pulses, but at other times is controlled by vertical-rate pulses.
- (3) The "4 times tonewheel" pulses in a video tape machine are derived from a locked oscillator which must be synchronized by actual tonewheel pulses when the headwheel is running, but must be synchronized by electronically-generated reference pulses when the headwheel is not running.
- (4) Some waveform monitors provide a choice of sync-tip or back-porch clamping. An easy way to provide this capability is by switching the

control of the clamp pulse generator from a positive-going sync source to a negative-going sync source (so that the generator circuits will be triggered by either leading or trailing edges of the pulses).

A simple digital circuit that may be used in each of these applications is shown in Fig. 24, along with a simple relay equivalent circuit. Note that this circuit is very similar to the machine-control circuit of Figure 8, but we are now assuming the use of electronic integrated circuits instead of relays (to achieve high switching speeds), and we are using NAND gates instead of basic AND or OR gates. The circuit of Fig. 24 could actually be constructed with

a single IC package, consisting of a set of four dual-input NAND gates; the one inverter required could be implemented by tying together the two inputs of one of the NAND gates.

An assumption implicit in Fig. 24 is that the pulse signals (identified here only as *Sync A* and *Sync B*) have been processed in such a way that they swing between the two logic levels (usually 0 and +5 volts) recognized by the logic elements. In some equipment where the external pulses signals may have other levels (such as 0 and -6 volts), *interface* stages may be needed to transform the pulse signals to standard logic levels before they are manipulated within the equipment.

If the SELECT SYNC B line in Fig. 24 is high, the lower NAND gate is enabled but the upper NAND gate is inhibited by the presence of a logic low at point (d). Under these circumstances, a fixed high will appear on line (e), but an inverted replica of the pulses at (b) will appear on line (f). Every time line (f) goes low, the output at (g) will go high. What will appear on line (g), therefore, is a replica of the pulse signal originally appearing at (b). (In some applications, the *propagation delay* involved in passing the signal through two gates in a series may become significant, but this factor is not critical in the majority of broadcast applications.)

If the SELECT SYNC B line goes low, the lower gate becomes inhibited and the upper gate is enabled. Under these circumstances, a fixed high appears on line (f), an inverted replica of SYNC A appears on line (e), and an exact replica of SYNC A (except for a minor propagation delay) will appear on line (g).

This popular circuit is commonly known as a *selector* circuit. Note that the use of a low-active OR gate symbol for the output gate contributes great clarity to the analysis of the circuit. Keep in mind that the low-active gate itself is electrically and physically identical to the NAND gates also used in the same circuit.

Positive and Negative Logic

As a final topic for this introductory paper, let us consider the significant differences between *positive logic* and *negative logic*—we shall also try to clarify the important distinction between a *truth table* and a *function table*. When logic functions are implemented with digital integrated circuits, the concepts of HIGH and LOW voltage levels are extremely helpful, both to the de-

sign engineer and to the maintenance technician. The levels are easy to visualize and to measure with meters, logic probes, or ordinary DC oscilloscopes. Strictly speaking, however, the logic symbols used on logic and schematic diagrams for digital equipment are defined in terms of the mathematician's *zero* and *one* states or the logician's *true* and *false* concepts. Proper interpretation of a logic diagram in terms of high or low voltage levels is possible only if one knows whether the draftsman used *positive* logic or *negative* logic.

Simply stated, *positive logic* in practical equipment results when the HIGH voltage state is arbitrarily assigned a meaning of "1" or TRUE and the LOW voltage state is assigned a meaning of "0" or FALSE. Entirely different logic symbols would be needed (and the physical design of the equipment would be quite different) if a designer chooses *negative logic*, in which the HIGH voltage level is arbitrarily assigned a meaning of "0" or FALSE and the LOW voltage level is assigned a meaning of "1" or TRUE.

The *function table* for a digital electronic circuit is unambiguous—it describes the output state for all possible combinations of input states, expressed as HIGH's or LOW's. The *truth table* for any circuit, however, and the appropriate logic symbol (or symbols) to represent its function are dependent upon the choice of positive or negative

logic. The differences between function tables and truth tables and the differences between positive and negative logics should become apparent through study of Figure 25, which summarizes the properties of the four most common gate circuits. Note that the very same block of circuitry which functions as an AND gate in positive logic becomes an OR gate in negative logic. In similar manner, OR become AND, NAND becomes NOR and NOR becomes NAND if the logic convention is switched from positive to negative.

All applications of digital technology to RCA broadcast equipment to date have been executed in positive logic and the symbols on our schematics and logic diagrams may be interpreted accordingly. The *labels* on incoming and outgoing lines are also expressed in *positive-true* logic. That is, taken literally, a label identifies the circumstances under which a given bus or control line is HIGH. As a practical matter, it is often useful to identify a bus like that at lower left in Fig. 9 as a "low-active Velocity Lock Bus", rather than as a "Not Velocity Lock" bus, but the former terminology is still consistent with positive logic. Across the industry as a whole, positive logic is clearly more popular than negative logic, but one should always ascertain which logic convention is being used before attempting to relate the data on a logic diagram to specific HIGH and LOW voltage levels. □

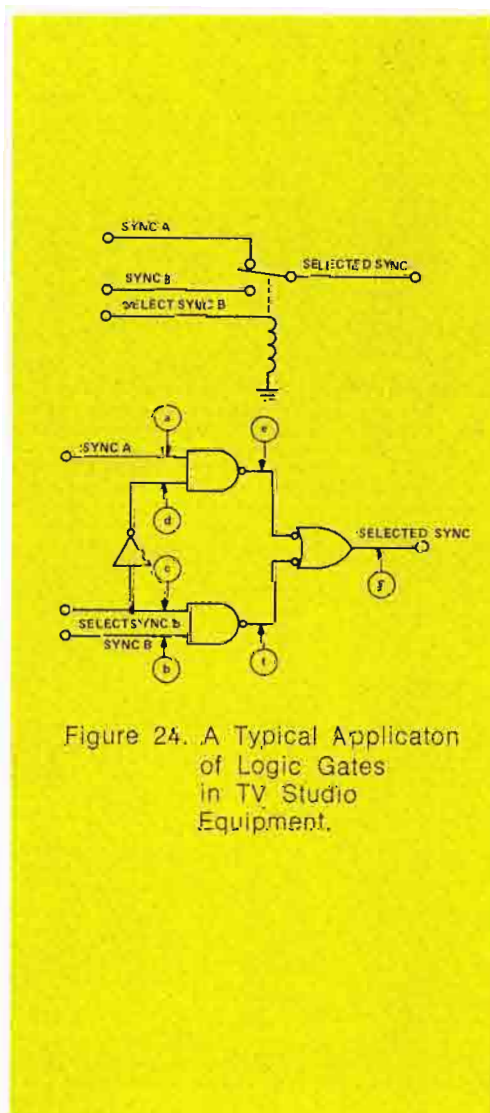

Figure 24. A Typical Application of Logic Gates in TV Studio Equipment.

FUNCTION TABLES (PROPERTIES OF PHYSICAL CIRCUITS)	TRUTH TABLES AND LOGIC SYMBOLS FOR POSITIVE LOGIC (L = 0 (FALSE), H = 1 (TRUE))	TRUTH TABLES AND LOGIC SYMBOLS FOR NEGATIVE LOGIC (L = 1 (TRUE), H = 0 (FALSE))																																													
<table border="1"> <tr><th>A</th><th>B</th><th>Y</th></tr> <tr><td>L</td><td>L</td><td>L</td></tr> <tr><td>L</td><td>H</td><td>L</td></tr> <tr><td>H</td><td>L</td><td>L</td></tr> <tr><td>H</td><td>H</td><td>L</td></tr> </table>	A	B	Y	L	L	L	L	H	L	H	L	L	H	H	L	<table border="1"> <tr><th>A</th><th>B</th><th>Y</th></tr> <tr><td>0</td><td>0</td><td>0</td></tr> <tr><td>0</td><td>1</td><td>0</td></tr> <tr><td>1</td><td>0</td><td>0</td></tr> <tr><td>1</td><td>1</td><td>0</td></tr> </table>	A	B	Y	0	0	0	0	1	0	1	0	0	1	1	0	<table border="1"> <tr><th>A</th><th>B</th><th>Y</th></tr> <tr><td>1</td><td>1</td><td>1</td></tr> <tr><td>1</td><td>0</td><td>1</td></tr> <tr><td>0</td><td>1</td><td>1</td></tr> <tr><td>0</td><td>0</td><td>1</td></tr> </table>	A	B	Y	1	1	1	1	0	1	0	1	1	0	0	1
A	B	Y																																													
L	L	L																																													
L	H	L																																													
H	L	L																																													
H	H	L																																													
A	B	Y																																													
0	0	0																																													
0	1	0																																													
1	0	0																																													
1	1	0																																													
A	B	Y																																													
1	1	1																																													
1	0	1																																													
0	1	1																																													
0	0	1																																													
<table border="1"> <tr><th>A</th><th>B</th><th>Y</th></tr> <tr><td>L</td><td>L</td><td>H</td></tr> <tr><td>L</td><td>H</td><td>H</td></tr> <tr><td>H</td><td>L</td><td>H</td></tr> <tr><td>H</td><td>H</td><td>H</td></tr> </table>	A	B	Y	L	L	H	L	H	H	H	L	H	H	H	H	<table border="1"> <tr><th>A</th><th>B</th><th>Y</th></tr> <tr><td>0</td><td>0</td><td>1</td></tr> <tr><td>0</td><td>1</td><td>1</td></tr> <tr><td>1</td><td>0</td><td>1</td></tr> <tr><td>1</td><td>1</td><td>1</td></tr> </table>	A	B	Y	0	0	1	0	1	1	1	0	1	1	1	1	<table border="1"> <tr><th>A</th><th>B</th><th>Y</th></tr> <tr><td>1</td><td>1</td><td>0</td></tr> <tr><td>1</td><td>0</td><td>0</td></tr> <tr><td>0</td><td>1</td><td>0</td></tr> <tr><td>0</td><td>0</td><td>0</td></tr> </table>	A	B	Y	1	1	0	1	0	0	0	1	0	0	0	0
A	B	Y																																													
L	L	H																																													
L	H	H																																													
H	L	H																																													
H	H	H																																													
A	B	Y																																													
0	0	1																																													
0	1	1																																													
1	0	1																																													
1	1	1																																													
A	B	Y																																													
1	1	0																																													
1	0	0																																													
0	1	0																																													
0	0	0																																													
<table border="1"> <tr><th>A</th><th>B</th><th>Y</th></tr> <tr><td>L</td><td>L</td><td>H</td></tr> <tr><td>L</td><td>H</td><td>H</td></tr> <tr><td>H</td><td>L</td><td>H</td></tr> <tr><td>H</td><td>H</td><td>L</td></tr> </table>	A	B	Y	L	L	H	L	H	H	H	L	H	H	H	L	<table border="1"> <tr><th>A</th><th>B</th><th>Y</th></tr> <tr><td>0</td><td>0</td><td>1</td></tr> <tr><td>0</td><td>1</td><td>1</td></tr> <tr><td>1</td><td>0</td><td>1</td></tr> <tr><td>1</td><td>1</td><td>0</td></tr> </table>	A	B	Y	0	0	1	0	1	1	1	0	1	1	1	0	<table border="1"> <tr><th>A</th><th>B</th><th>Y</th></tr> <tr><td>1</td><td>1</td><td>0</td></tr> <tr><td>1</td><td>0</td><td>0</td></tr> <tr><td>0</td><td>1</td><td>0</td></tr> <tr><td>0</td><td>0</td><td>1</td></tr> </table>	A	B	Y	1	1	0	1	0	0	0	1	0	0	0	1
A	B	Y																																													
L	L	H																																													
L	H	H																																													
H	L	H																																													
H	H	L																																													
A	B	Y																																													
0	0	1																																													
0	1	1																																													
1	0	1																																													
1	1	0																																													
A	B	Y																																													
1	1	0																																													
1	0	0																																													
0	1	0																																													
0	0	1																																													
<table border="1"> <tr><th>A</th><th>B</th><th>Y</th></tr> <tr><td>L</td><td>L</td><td>L</td></tr> <tr><td>L</td><td>H</td><td>L</td></tr> <tr><td>H</td><td>L</td><td>L</td></tr> <tr><td>H</td><td>H</td><td>L</td></tr> </table>	A	B	Y	L	L	L	L	H	L	H	L	L	H	H	L	<table border="1"> <tr><th>A</th><th>B</th><th>Y</th></tr> <tr><td>0</td><td>0</td><td>1</td></tr> <tr><td>0</td><td>1</td><td>0</td></tr> <tr><td>1</td><td>0</td><td>0</td></tr> <tr><td>1</td><td>1</td><td>0</td></tr> </table>	A	B	Y	0	0	1	0	1	0	1	0	0	1	1	0	<table border="1"> <tr><th>A</th><th>B</th><th>Y</th></tr> <tr><td>1</td><td>1</td><td>0</td></tr> <tr><td>1</td><td>0</td><td>1</td></tr> <tr><td>0</td><td>1</td><td>1</td></tr> <tr><td>0</td><td>0</td><td>1</td></tr> </table>	A	B	Y	1	1	0	1	0	1	0	1	1	0	0	1
A	B	Y																																													
L	L	L																																													
L	H	L																																													
H	L	L																																													
H	H	L																																													
A	B	Y																																													
0	0	1																																													
0	1	0																																													
1	0	0																																													
1	1	0																																													
A	B	Y																																													
1	1	0																																													
1	0	1																																													
0	1	1																																													
0	0	1																																													
<table border="1"> <tr><th>A</th><th>B</th><th>Y</th></tr> <tr><td>L</td><td>L</td><td>L</td></tr> <tr><td>L</td><td>H</td><td>H</td></tr> <tr><td>H</td><td>L</td><td>H</td></tr> <tr><td>H</td><td>H</td><td>L</td></tr> </table>	A	B	Y	L	L	L	L	H	H	H	L	H	H	H	L	<table border="1"> <tr><th>A</th><th>B</th><th>Y</th></tr> <tr><td>0</td><td>0</td><td>0</td></tr> <tr><td>0</td><td>1</td><td>1</td></tr> <tr><td>1</td><td>0</td><td>1</td></tr> <tr><td>1</td><td>1</td><td>1</td></tr> </table>	A	B	Y	0	0	0	0	1	1	1	0	1	1	1	1	<table border="1"> <tr><th>A</th><th>B</th><th>Y</th></tr> <tr><td>1</td><td>1</td><td>1</td></tr> <tr><td>1</td><td>0</td><td>0</td></tr> <tr><td>0</td><td>1</td><td>0</td></tr> <tr><td>0</td><td>0</td><td>1</td></tr> </table>	A	B	Y	1	1	1	1	0	0	0	1	0	0	0	1
A	B	Y																																													
L	L	L																																													
L	H	H																																													
H	L	H																																													
H	H	L																																													
A	B	Y																																													
0	0	0																																													
0	1	1																																													
1	0	1																																													
1	1	1																																													
A	B	Y																																													
1	1	1																																													
1	0	0																																													
0	1	0																																													
0	0	1																																													

Figure 25. Comparisons of Positive and Negative Logic.

new on-line editing system...

*for TR-600
Quad VTR's*



AE-600 System Configuration

AE-600 Editing System is capable of controlling one record and up to eight playback TR-600 VTR's.

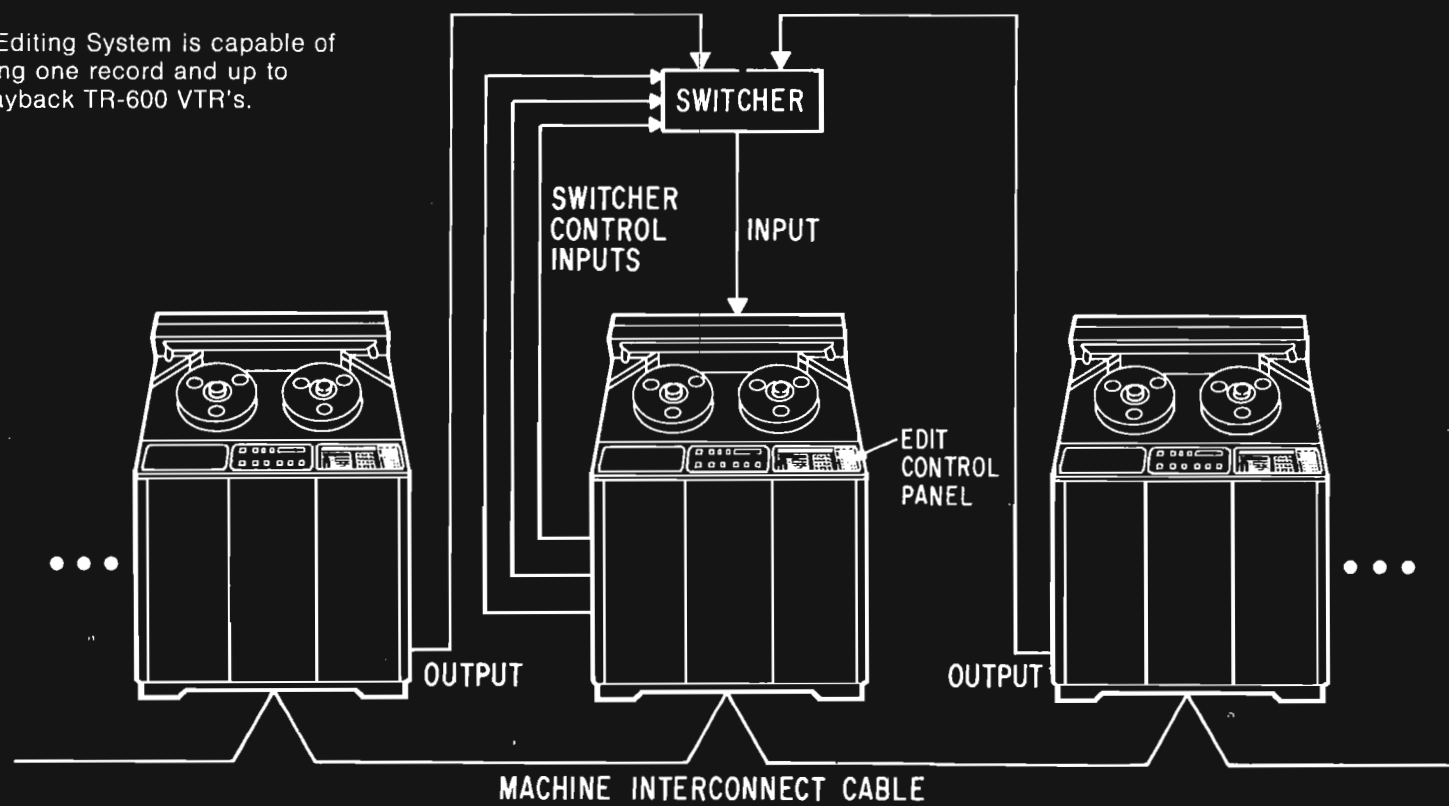

Robert T. McKinley
Electronic Recording Equipment Engineering

Ideally, new systems designs start with the user. This approach is especially necessary with designs involving sophisticated technology such as tape editing systems.

In developing the AE-600 Time Code Editing System, our primary objective was to provide the operator with total flexibility for expanding artistic creativity. A second important and related goal was to minimize the technical, non-creative delays associated with editing systems, thus enhancing productivity. By integrating the new AE-600 Edit Controller with the RCA TR-600, these objectives are being accomplished.

The philosophy adopted in the design of the AE-600 microprocessor edit controller was one of versatility. Not only was the edit machine to handle complex creative edits, but the entire editing system was to offer a degree of flexibility not available with existing systems to date.

The AE-600 editing system is capable of controlling one record and up to eight playback TR-600's. In any given system, any one of the TR-600's can be delegated as the Edit, or record, machine. This delegation is made by selecting either an Insert or Add-on mode on the Edit Control panel. The Control Panels can be mounted either on the TR-600 or at a remote location. Electronic interlocks insure that only one machine at a time is allowed to be the Edit machine.

Depending on daily editing requirements, any or all of the playback machines can be delegated for use in the editing system. Playback machine delegation is made from the keyboard of the Edit Control panel on the Edit

machine. Machines connected in the system which are not required by the Edit VTR are available for other use. Master recordings and other playback duties are possible with these non-delegated machines. Total communication between all machines in the system is accomplished over a thin cable of 3 twisted-pair wires. This cable is looped through all the machines in the system and provide transfer of the required edit and transport control functions.

All AE-600 electronics are integral to the TR-600, housed in a module case which mounts in the back of the machine. This module cage, added to the basic TR-600, includes its own power supply and holds six printed circuit boards which contain the central processing unit and memory electronics for the editing system.

The new editing system offers significant time savings in both the cueing and synchronizing functions. By minimizing these technical delays, more time is available to the creative artist for making edit decisions. Two reasons account for this time saving. First, the AE-600 was designed with a microprocessor. Using the Intel 8080 microprocessor and supported with 15K of memory, several more functions could be executed than would be feasible with hardwired logic gates. Second, the AE-600 was designed specifically as an integral part of the TR-600 VTR. Functional techniques committed in the memory of the AE-600 have been optimized for the particular operating characteristics of the TR-600.

Let's see how this works. In the cueing function, the VTR must wind, or "search", to a particular spot on tape as identified by the time code on the

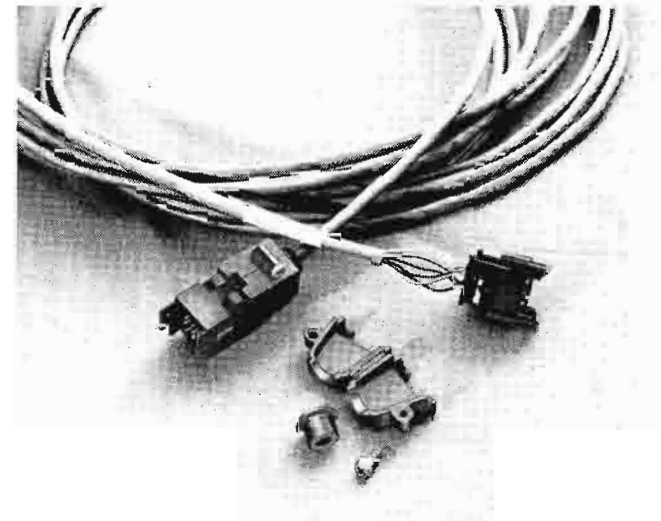

Three twisted pair wires tie editing system machines together.

AE-600 electronics mount inside TR-600, housed in a module case with separate power supply and six circuit boards.

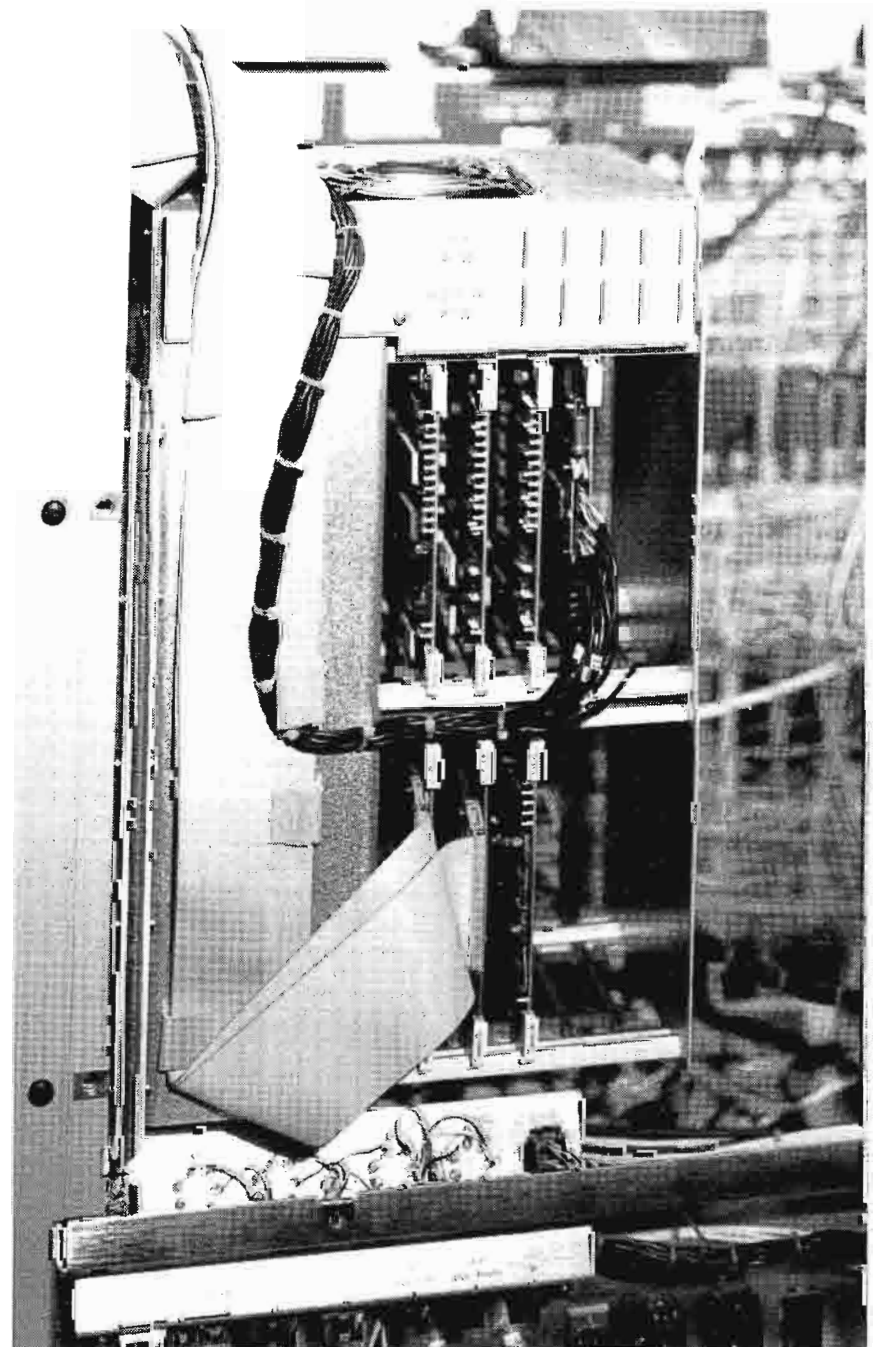

AE-600 Cueing

$$a = F/m \quad \text{WHERE } a = \text{ACCELERATION OR DECELERATION}$$

$$F = \text{FORCE APPLIED BY TORQUE OF REEL MOTORS}$$

$$m = \text{MASS OF REELS OF TAPE, REEL HUB AND MOTOR ROTOR}$$

$$V \cdot t \text{ at } x = 1/2 at^2$$

$$V = \sqrt{2ax}$$

$V = \text{VELOCITY}$
 $X = \text{DISTANCE}$
 $t = \text{TIME}$

GIVEN a & X , AE-600 SUBROUTINE COMPUTES V

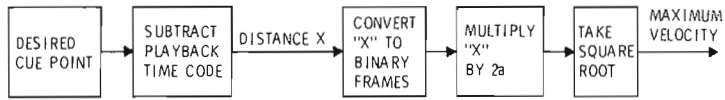

cue track. The objective is to it as fast and as accurate as possible.

When cueing, the tape handling system of the TR-600 is considered to be a constant acceleration system. Therefore, from physics, the acceleration of the system is determined by the equation $a = F/m$ (where a = acceleration [or deceleration], F = force applied by the torque of the reel motors, and m = the mass of the reels of tape, plus the mass of the reel hub and motor rotor). When given the distance available to stop, X , and the acceleration of the system, the maximum velocity can be calculated from the relationship of $V = \sqrt{2aX}$. This equation was derived from the equations $V = at$ and $X = \frac{1}{2} at^2$. The cue subroutine within the microprocessor system computes X from the tape time code and the desired cue point using these equations. The distance X is then converted to binary frames, multiplied by the constant $2a$, and the square root is taken to get the maximum velocity. This velocity is outputted to an 8 bit D/a converter and serves as the reference during the cueing. The actual tape velocity, derived from tach pulses in the Reel Servo subsystem, is compared to the reference velocity. This comparison creates an error voltage which controls a pulse width and frequency modulator. The output of the modulator is fed to the machine wind busses to control tape speed.

The constant, $2a$, used to determine the reference velocity is not always constant. It varies depending on the

AE-600 Cueing Functional Block Diagram

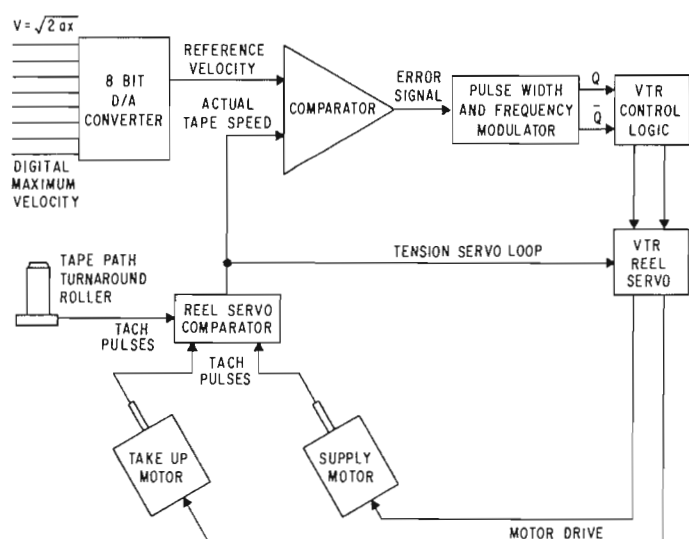

AE-600 Synchronizing Functional Block Diagram

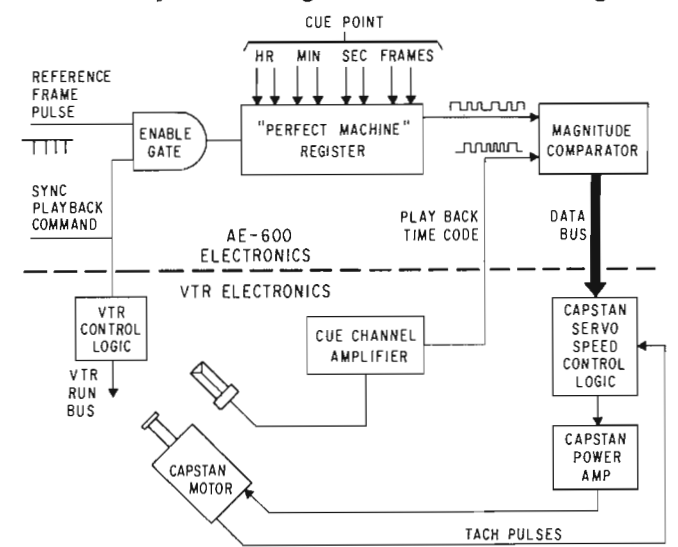

size of the reels and the speed at which the time code was recorded, 15 or 7.5 ips. By monitoring various points within the TR-600, the AE-600 microprocessor accounts for all these variables. It also knows to cut the constant $2a$ in half exactly four seconds, tape time, before the cue point. This optimizes the interaction of the dynamic and mechanical braking action. The result of all this communication between machine and microprocessor is a system which quickly accelerates and decelerates to the desired cue point with frame accuracy.

The synchronizing time with the AE-600 has also been greatly reduced. In NTSC, all machines are color framed and synchronized in two seconds. When synchronization has been detected, the AE-600 does not release control back to the normal capstan servo. Instead, it maintains direct control until lockup by means of a data bus between the microprocessor and capstan servo.

Within the microprocessor, a register is preset with the cue point. This register is a model of a "perfect machine". It parks right on the cue point and has no inertia so it can start instantaneous-



ly. When a sync playback command is received, this register is incremented with the reference frame pulse. At the same time, the VTR will start to roll from the cue point. By comparing the VTR's playback time code to the incrementing "perfect machine" register, an error signal results which will bring the real machine right in step with its perfect model. This error signal is in the form of a digital word which programs the capstan speed in fractions of frame increments until the servo has properly locked. Fast, reliable synchronization results, significantly cutting down the time required for preview and editing. And since all the machines in the system synchronize to their own "perfect machine", the cumbersome routing of the Edit machines time code from the cue output to the input of the playback machines has been eliminated.

As well as helping to optimize machine performance, the AE-600 is instrumental in optimizing editor creativity. By providing a highly "human-engineered" control panel with several key operating features, a high degree of freedom is available to the operator for efficiently executing creative edits.

The edit control panel has been keyed to maximum user effectiveness. Control buttons have been arranged in logical order from left to right to minimize operator error and to speed operation. With multiplexing techniques, the 46 switches on the control panel provide 64 separate functions. Several keys have upper case functions, very similar to the scientific pocket calculators. With the use of LED tally lights, an operator can tell at a glance the total system status. Two seven segment LED displays are also provided. The one on

Human-engineered AE-600 edit control panel is keyed for ease of operation, with controls grouped to minimize operator errors and to speed editing operation. Compact keyboard controls 64 separate edit functions



AE-600 System Edit Capability

- SPLIT AUDIO-ONLY, VIDEO-ONLY AND AUDIO/VIDEO EDITS
- 3 INDEPENDENT EDITS ON SAME PASS OF TAPE
- 3 "EVENT" RELAY CLOSURES TO CONTROL ETHERNET EQUIPMENT
 - 1 RELAY CLOSURE AT "IN" EDIT POINT
 - 2 PROGRAMMABLE RELAY CLOSURES

AE-600 Operational Modes

- AUTO UPDATE
- ANIMATE
- REGISTER TRANSFER
- 999 FRAMES MOD
- MANUAL UPDATE
- LAST ENTRY
- MASTER RECALL
- REPLAY
- SYNC PB
- PLAYBACK TRANSFER

the left is delegated to display time code. The right display is used for modifying in or out edit times and other functions which require a digital display to simplify operation.

From this control panel, split audio-only, video-only and audio/video edits can be programmed, previewed and executed. Edit points can be stored on the fly, keyed into memory with the keyboard, or fed to the AE-600 from external computer storage. The "Event Relay" closures can also be programmed from the keyboard for controlling external equipment.

Taking advantage of the vast capability of a microprocessor system, the AE-600 contains many innovative user-oriented features. Let's take a few examples. "Auto-Update"—if this mode of operation is selected, after an edit has been made, the out time becomes the next edit in time. This feature is quite convenient when assembling a tape where the new segment would start immediately following the previous segment. Although a simple routine for the microprocessor, it saves the operator considerable time.

With the "999 Frame Modification" mode, edit points can be shifted in frame increments from 0 to 999 by keying in the desired amount—no need to convert X number of frames into seconds and frames. If, during an editing session, one realizes the editorial content of the edits is not flowing just right, the operator might use the "Master Recall" button. This button controls a three stack memory which will reconstruct all the in and out times of the previous edit, or, if desired, the edit before that one. In this way, the sequence of edits can be modified as required and then repeated until totally satisfied.

The AE-600 editing system does not need to be "previewed to death". The five preview modes offered are executed quickly due to the fast and accurate cueing and synchronizing functions. Both the playback machines and the edit machines can be previewed separately from the edit machine. In the Program preview, all machines involved in the edit will roll and give an accurate indication of what the edit will look like. Two other preview modes (B-P-B out) (P-P-P out) will preview just the out times of the record

and playback machines. If one of these preview modes is selected, the machines will cue to four seconds before the out edit time and then do the preview. This saves considerable time, as compared to having to do an entire preview, when all you are interested in is seeing the out edit point.

Complementing the AE-600 edit controller are additional user-oriented components of a total time code editing system. The first facility is a state-of-the-art time code reader contained on two TR-600 modules. Complete with an Intel 4040 microprocessor, the time code reader will handle tape speeds from 1/10 to 100 times normal. This wide range ability affords manual cueing of the tape reels with an accurate time code display.

The second component is a time code generator built on a single module. This module was designed around a custom COS/MOS integrated circuit which generates the 80 bit SMPTE time code.

AE-600 Preview Modes

- PROGRAM—BLACK—PROGRAM (EDIT MACHINE)
- BLACK—PROGRAM—BLACK (PLAYBACK MACHINES)
- PROGRAM—PROGRAM—PROGRAM (ALL MACHINES)
- B-P-B OUT (PLAYBACK MACHINES)
- P-P-P OUT (EDIT MACHINE)

AE-600 System Components

- TIME CODE READER
- TIME CODE GENERATOR
- VIDEO CHARACTER GENERATOR
- EXTERNAL MONITOR DISPLAY

Thumbwheel switches on the module allow presetting the generator to any desired time. Other features include a counter reset, drop frame/non-drop frame operation and user bit coding. The generator can also be synchronized to tape time to provide continuous add-on time code recordings.

A third facility is the video character generator module. Complete with position controls, the time code display is added to the monitor video. Switches are provided to blank the frames display and add a black mask behind the character display at the user's option.

The final feature is an external monitor display which can be used in conjunction with the remote AE-600 control panels. The monitor display offers a visual presentation of the individual in,

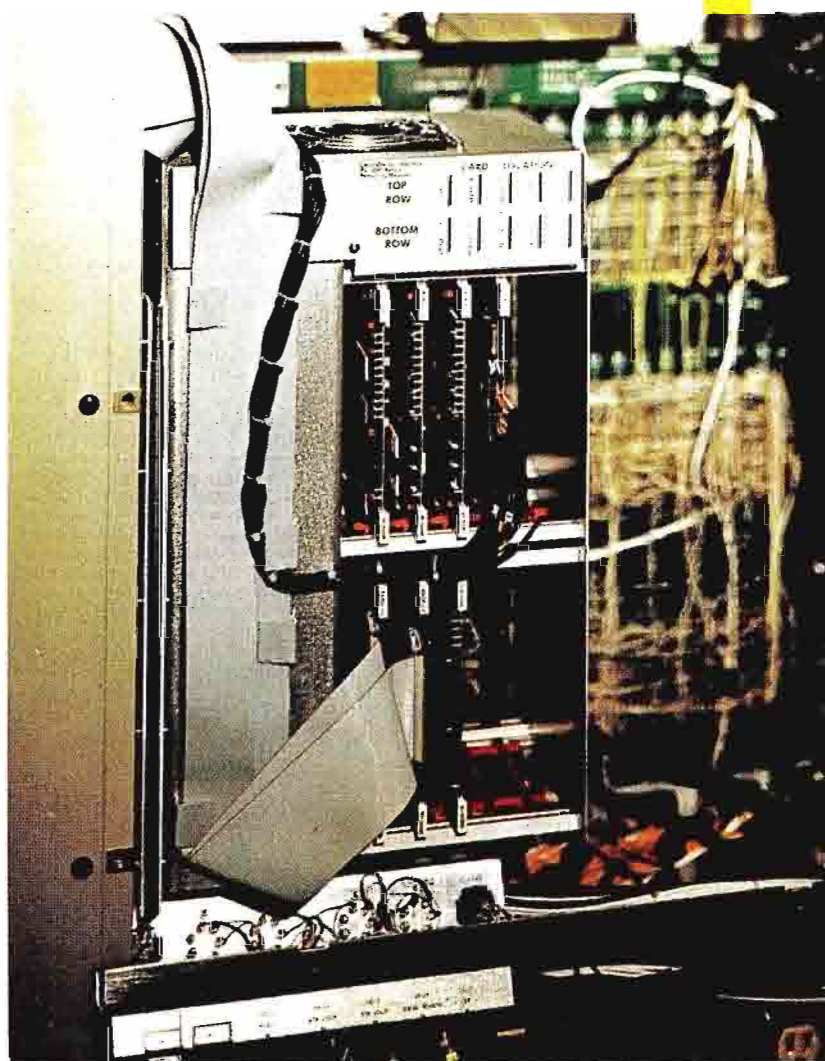
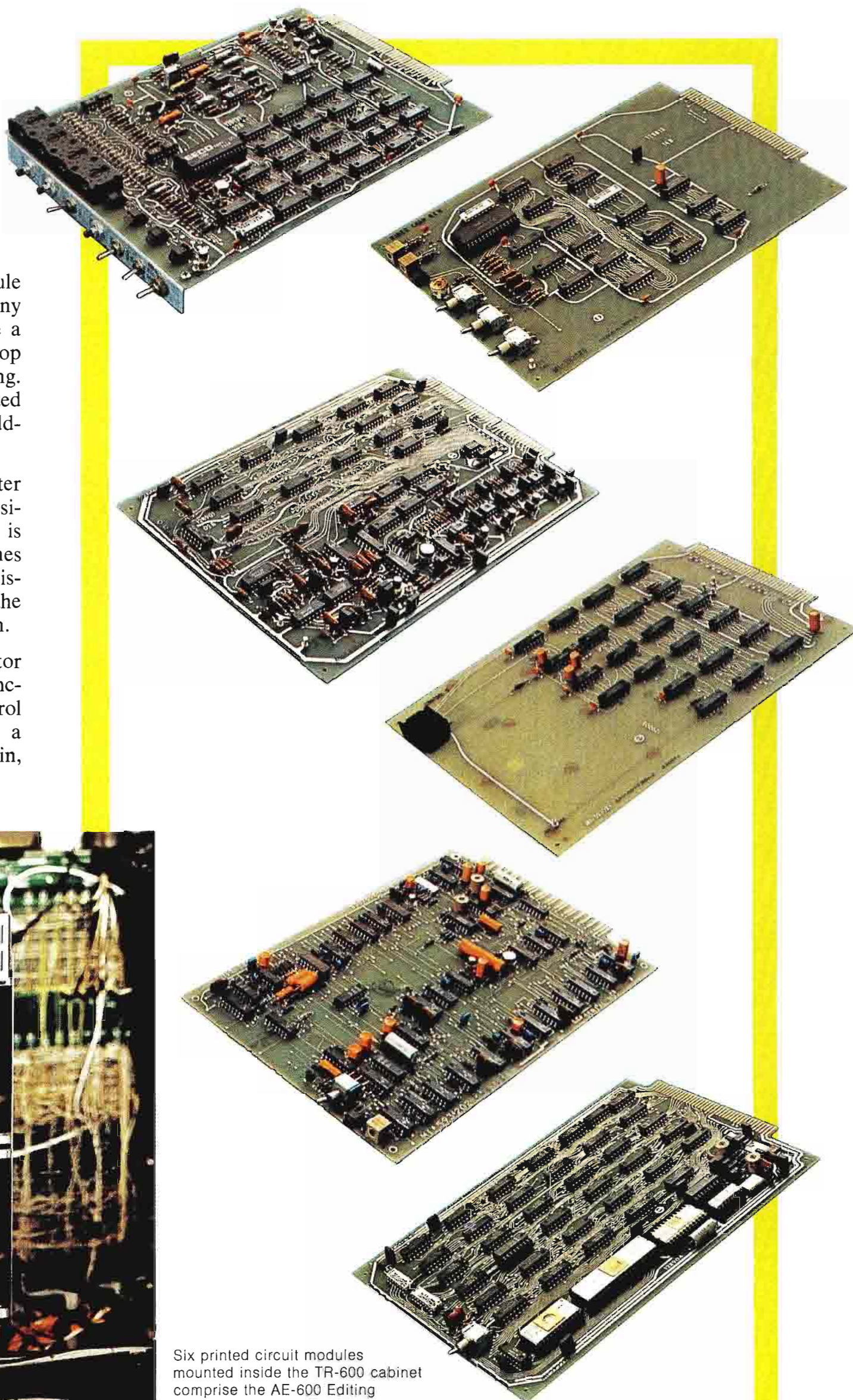

Six printed circuit modules mounted inside the TR-600 cabinet comprise the AE-600 Editing System.



External monitor display provides a visual display of individual "In", "Out" and "Duration" times for all machines in the system.

out and duration times for all machines enabled in the system. An output is also available to provide a hardcopy printout of the edit decision points.

To optimize VTR performance, improvements were made to the start up characteristics of the Reel Servo. The tape now gets up to speed much quicker. This allows for much smoother and accurate cueing. Also, the Super High-band deviation standard and a continuous pilot tone error correction technique were added to the FM and Video Subsystems. By minimizing first line errors and extending the signal to noise and moire specifications, these features allow for higher quality dubbing and editing.

In order to minimize VTR setup functions, new innovative edit subsystem designs were developed. The first one, the Edit Servo, was designed to automatically setup the tach, or tonewheel phase, for each tape before editing.

Contained on one TR-600 module, the Edit Servo acts as an additional loop within the headwheel servo system. Each time a new tape is loaded on the VTR, the servo circuitry is activated. A comparison is made between tape sync and reference sync pulses through a digital phase comparator. A digital to analog converter creates an error voltage which represents the timing error between tape and reference sync. This error signal drives a pulse width modulator, its output controlling the phase of the headwheel. The entire process proceeds closed-loop until there is exact coincidence between the sync pulses. This coincidence assures that

when an edit is made there is no discontinuity between the new and previous material recorded on tape.

A Color Framing Detector has been added to align the playback video 4 field sequence with that of the input video 4 field sequence. This alignment is necessary to eliminate the chroma shift, or "color flash", resulting when edits are made on the wrong color field.

This Color Framing Detector eliminates the need for 15 Hz Edit Pulses which were previously used to achieve the same results.

Color Framing operation is simple. First, the burst phase relative to the leading edge of sync is determined for both the tape and reference video. Then a comparison is made. If the tape phase is not within plus or minus 90 degrees of the reference phase, the capstan will proceed to lock the next frame pulse. At this next frame pulse, the tape phase will be within plus or minus 90 degrees of the reference. The servo would not be ready for correct color field editing.

An Edit Display has also been incorporated in the TR-600 VTR. The display consists of a black box and three white lines which can be switched into the monitor video. This display offers positive feedback from the Edit Servo to the VTR operator. Using the upper and lower lines as a reference, the relative position of the center line shows how tightly the edit servo has aligned the headwheel to the input video. Under normal operation, the display will appear as one vertical white line, indicating proper tonewheel phasing.

Edit Servo Functional Block Diagram

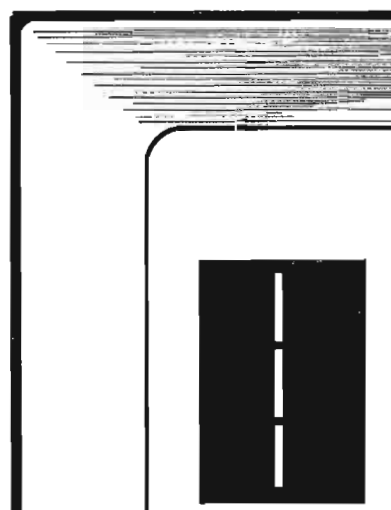
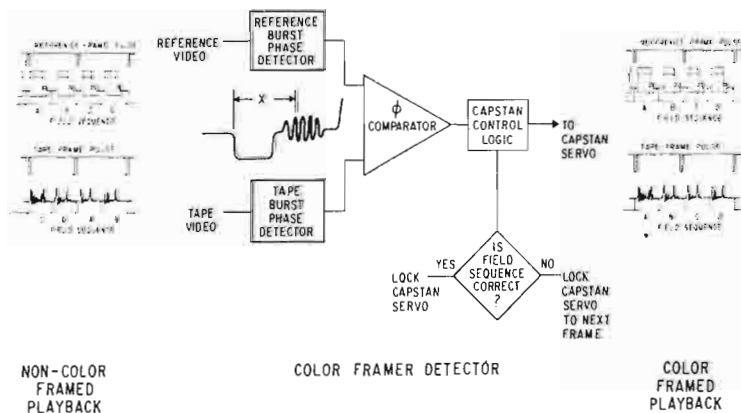
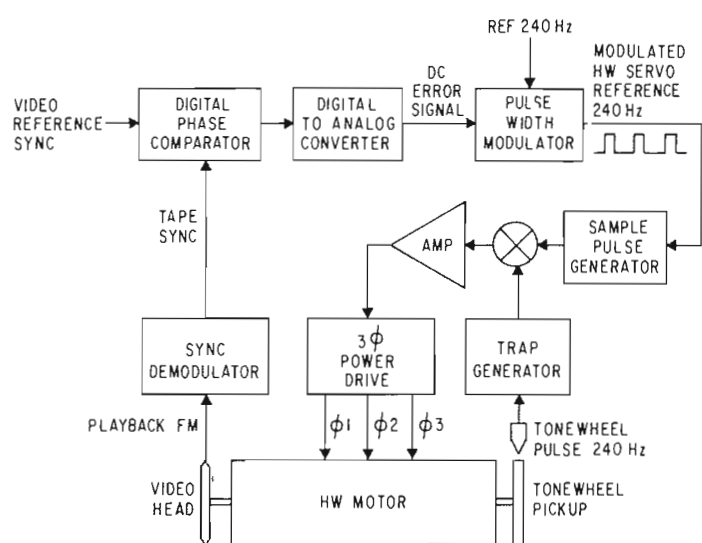

Edit display offers positive feedback from Edit Servo to the VTR operator

In Summary

The combination of the automated edit functions of the TR-600 with the advanced AE-600 Edit Controller design establish new value and performance parameters for on-line editing. By minimizing technical delays, providing system flexibility and user-oriented features, the design objectives have been achieved: easier, faster and more productive editing, without restrictions on creativity. □

PRIME TIME

ANTENNAS AND TRANSMITTERS

WTAF-TV, PHILADELPHIA, BROADCASTS THE WORLD'S MOST POWERFUL OMNIDIRECTIONAL TV SIGNAL.

"When we put our new system on-air in 1974, Ch. 29's 'A' market coverage went up 68% to 9,870 square miles," reports Taft Broadcasting Corporate Vice President Bill Hansher.

"... 'A' market coverage up 68%."

"Viewer reaction was extremely favorable—we were even getting responses from Manhattan, Baltimore and Western Pennsylvania.

"Our 5 megawatt signal makes WTAF-TV the most powerful omnidirectional TV station anywhere—but we achieved our maximum ERP with operating savings of 25%, thanks to RCA planning.

"We selected their TTU-165c transmitter and a 40-gain TFCU-40 antenna. Since this 165 kW UHF transmitter needs less primary power, and cost us less than a 220 kW transmitter would have, we realize very welcome economies.

"...operational savings of 25%."

"More than two years later, we're totally pleased with the RCA system's performance."

For more about the WTAF package, see **Broadcast News #155.**

RCA READY WITH THREE CIRCULARLY POLARIZED ANTENNAS.

When FCC approval is granted, RCA will be able to help stations improve their signals with three circularly polarized TV antennas.

One is a top-mounted Fan-Vee for Channels 2 through 6. It uses individual radiators for horizontal and vertical polarization. They are phased to produce the circularly polarized pattern.

Another circularly polarized antenna, the End Fire Helix, is for Channels 7-13. It uses three small reflecting dishes mounted per layer around the top-mounting pole to

produce an omnidirectional circularly polarized pattern.

A panel antenna for face mounting on the tower (Channels 7-13) may be installed as a horizontally polarized antenna, with the ability to be converted to circular polarization.

Ask your RCA Representative for full antenna information.

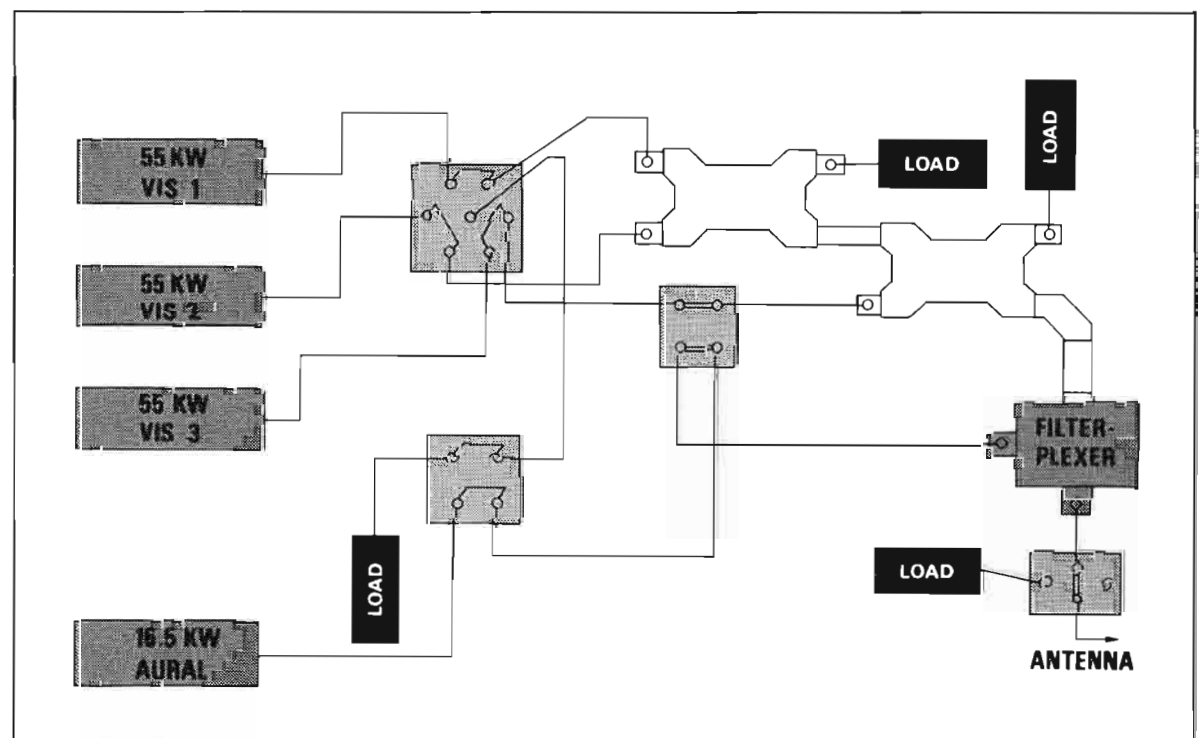
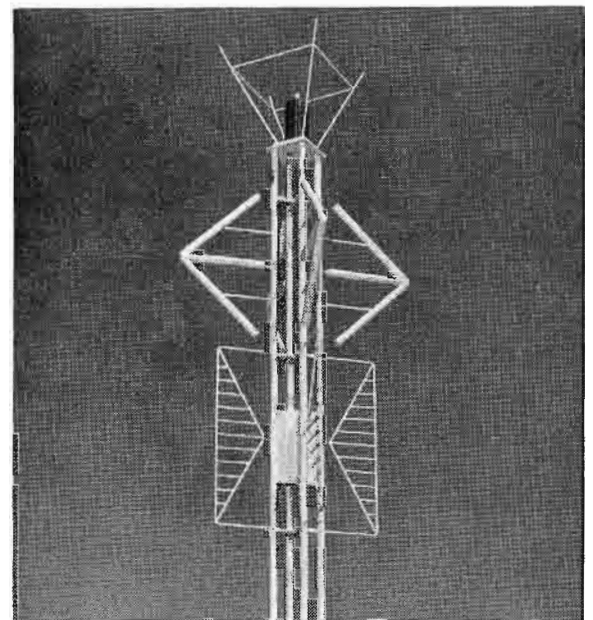
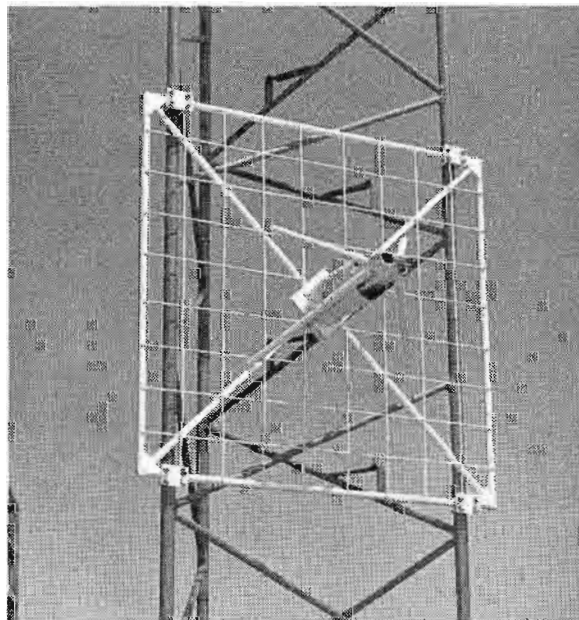

Four 55 kW vapor-cooled klystrons are used in the TTU-165c. A unique triplexing system developed for the WTAF-TV transmitting plant combines the outputs of three of the klystrons. As shown in the diagram, visual amplifiers 1

and 2 are combined through a 3 dB combiner to produce 110 kW peak power. The signal is fed through a 4.77 dB combiner where it is added to the output of visual amplifier 3 for combined visual peak power of 165 kW.

